

Agilent 5975 Series MSD

Operation Manual



Agilent Technologies

Notices

© Agilent Technologies, Inc. 2012

No part of this manual may be reproduced in any form or by any means (including electronic storage and retrieval or translation into a foreign language) without prior agreement and written consent from Agilent Technologies, Inc. as governed by United States and international copyright laws.

Manual Part Number

G3170-90036

Edition

Fourth edition, June 2012

Replaces G3170-90030

Printed in USA

Agilent Technologies, Inc.
5301 Stevens Creek Boulevard
Santa Clara, CA 95052

Warranty

The material contained in this document is provided “as is,” and is subject to being changed, without notice, in future editions. Further, to the maximum extent permitted by applicable law, Agilent disclaims all warranties, either express or implied, with regard to this manual and any information contained herein, including but not limited to the implied warranties of merchantability and fitness for a particular purpose. Agilent shall not be liable for errors or for incidental or consequential damages in connection with the furnishing, use, or performance of this document or of any information contained herein. Should Agilent and the user have a separate written agreement with warranty terms covering the material in this document that conflict with these terms, the warranty terms in the separate agreement shall control.

Safety Notices

CAUTION

A **CAUTION** notice denotes a hazard. It calls attention to an operating procedure, practice, or the like that, if not correctly performed or adhered to, could result in damage to the product or loss of important data. Do not proceed beyond a **CAUTION** notice until the indicated conditions are fully understood and met.

WARNING

A **WARNING** notice denotes a hazard. It calls attention to an operating procedure, practice, or the like that, if not correctly performed or adhered to, could result in personal injury or death. Do not proceed beyond a **WARNING** notice until the indicated conditions are fully understood and met.

About This Manual

This manual contains information for operating and maintaining the Agilent 5975 Series Gas Chromatograph/Mass Selective Detector (GC/MSD) system.

1 “Introduction”

Chapter 1 describes general information about the 5975 Series MSDs, including a hardware description, general safety warnings, and hydrogen safety information.

2 “Installing GC Columns”

Chapter 2 shows you how to prepare a capillary column for use with the MSD, install it in the GC oven, and connect it to the MSD using the GC/MSD interface.

3 “Operating in Electron Impact (EI) Mode”

Chapter 3 describes basic tasks such as setting temperatures, monitoring pressures, tuning, venting, and pumpdown. Much of the information in this chapter also applies to CI operation.

4 “Operating in Chemical Ionization (CI) Mode”

Chapter 4 describes additional tasks necessary to operate in CI mode.

5 “General Maintenance”

Chapter 5 describes maintenance procedures common to both EI and CI instruments.

6 “CI Maintenance”

Chapter 6 describes maintenance procedures unique to CI MSDs.

A “Chemical Ionization Theory”

Appendix A is an overview of chemical ionization theory.

Online User Information

Now your Agilent instrument documentation is in one place, at your fingertips.



The Instrument Utilities DVD that ships with your instrument provides an extensive collection of online help, videos, and books for the Agilent **7890A GC, 7820A GC, 6890N GC, 6850 GC, 5975T LTM GC/MS, 7693A ALS**, and the **7683B ALS**. Included are localized versions of the information you need most, such as:

- Getting Familiar documentation
- Safety and Regulatory guides
- Site Preparation checklists
- Installation information
- Operating guides
- Maintenance information
- Troubleshooting details

Contents

1 Introduction

5975 MSD Version	10
Abbreviations Used	11
The 5975 Series MSD	13
CI MSD Hardware Description	15
Important Safety Warnings	17
Hydrogen Safety	19
GC precautions	19
Safety and Regulatory Certifications	24
Cleaning/Recycling the Product	27
Liquid Spillage	27
Moving or Storing the MSD	27

2 Installing GC Columns

Columns	30
To reconfigure a 6850 GC column on its basket	32
To prepare a capillary column for installation	37
To install a capillary column in a split/splitless inlet	39
To condition a capillary column	41
To install a capillary column in the GC/MSD interface	43
Agilent 7890A and 7820A, and 6890 GCs	43
6850 GC	45

3 Operating in Electron Impact (EI) Mode

Operating the MSD from the Data System	51
--	----

Operating the MSD from the LCP	51
Modes of operation	51
LCP Status Messages	53
ChemStation Loading <timestamp>	53
Executing <type>tune	53
Instrument Available <timestamp>	53
Loading Method <method name>	53
Loading MSD Firmware	53
Loading OS	54
<method> Complete <timestamp>	54
Method Loaded <method name>	54
MS locked by <computer name>	54
Press Sideplate	54
Run: <method> Acquiring <datafile>	54
To view system status during startup	54
LCP Menus	55
The EI GC/MSD Interface	58
Before You Turn On the MSD	60
Pumping Down	61
Controlling Temperatures	61
Controlling Column Flow	62
Venting the MSD	63
To view MSD analyzer temperature and vacuum status	64
To set monitors for MSD temperature and vacuum status	66
To set the MSD analyzer temperatures	67
To set the GC/MSD interface temperature from the ChemStation	69
To monitor high vacuum pressure	71

To measure column flow linear velocity	73
To confirm column flow	74
To tune the MSD	75
To verify system performance	76
High-Mass Testing (5975 Series MSDs)	77
To remove the MSD covers	80
To vent the MSD	82
To open the analyzer chamber	84
To close the analyzer chamber	87
To pump down the MSD	91
To move or store the MSD	93
To set the interface temperature from the GC	95

4 Operating in Chemical Ionization (CI) Mode

General Guidelines	98
The CI GC/MSD Interface	99
To Operate the CI MSD	101
To switch from the EI source to the CI source	102
To pump down the CI MSD	103
To set up the software for CI operation	104
To operate the reagent gas flow control module	106
To set up methane reagent gas flow	109
To use other reagent gases	111
To switch from the CI source to the EI source	115
CI Autotune	116

To perform a PCI autotune (methane only)	118
To perform an NCI autotune (methane reagent gas)	120
To verify PCI performance	122
To verify NCI performance	123
To monitor high vacuum pressure	124

5 General Maintenance

Before Starting	128
Maintaining the Vacuum System	133

6 CI Maintenance

General Information	140
To Set Up Your MSD for CI Operation	141

A Chemical Ionization Theory

Chemical Ionization Overview	146
Positive CI Theory	148
Negative CI Theory	155

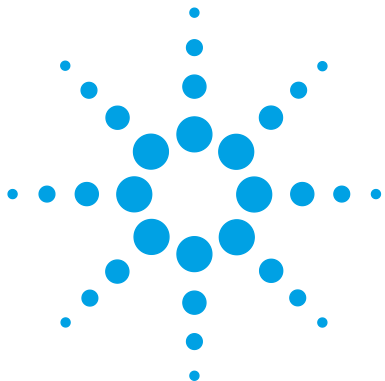

1 Introduction

5975 MSD Version	10
Abbreviations Used	11
The 5975 Series MSD	13
CI MSD Hardware Description	15
Important Safety Warnings	17
Many internal parts of the MSD carry dangerous voltages	17
Electrostatic discharge is a threat to MSD electronics	17
Many parts are dangerously hot	18
The oil pan under the standard foreline pump can be a fire hazard	18
Hydrogen Safety	19
Dangers unique to GC/MSD operation	20
Hydrogen accumulation in an MSD	20
Precautions	22
Safety and Regulatory Certifications	24
Information	24
Symbols	25
Electromagnetic compatibility	26
Sound emission declaration	26
Cleaning/Recycling the Product	27
Liquid Spillage	27
Moving or Storing the MSD	27

This manual describes the operation, and routine maintenance of the Agilent Technologies 5975 Series MSD.

5975 MSD Version

5975 Series MSDs are equipped with a diffusion pump or one of two turbomolecular (turbo) pumps. The serial number label displays a product number (Table 1) that indicates what kind of MSD you have.

Table 1 Available high vacuum pumps

Model name	Product number	Description	Ionization modes
5975C TAD VL MSD	G3170A	Diffusion Pump MSD	Electron impact (EI)
5975C TAD inert MSD	G3171A	Standard Turbo MSD	Electron impact (EI)
	G3172A	Performance Turbo MSD	Electron impact (EI)
5975C TAD inert XL MSD			
5975C TAD inert XL MSD	G3174A	CI High Mass Performance Turbo Pump	Electron impact (EI) Negative chemical ionization (NCI) Positive chemical ionization (PCI)
7820 MSD VL	G3175A	Diffusion Pump MSD	Electron impact (EI)
7820 MSD	G3176A	Standard Turbo MSD	Electron impact (EI)

Abbreviations Used

The abbreviations in [Table 2](#) are used in discussing this product. They are collected here for convenience.

Table 2 Abbreviations

Abbreviation	Definition
AC	Alternating current
ALS	Automatic liquid sampler
BFB	Bromofluorobenzene (calibrant)
CI	Chemical ionization
DC	Direct current
DFTPP	Decafluorotriphenylphosphine (calibrant)
DIP	Direct insertion probe
DP	Diffusion pump
EI	Electron impact ionization
EM	Electron multiplier (detector)
EMV	Electron multiplier voltage
EPC	Electronic pneumatic control
eV	Electron volt
GC	Gas chromatograph
HED	High-energy dynode (refers to detector and its power supply)
id	Inside diameter
LAN	Local Area Network
LCP	Local control panel (on the MSD)
LTM	Low thermal mass
m/z	Mass to charge ratio
MFC	Mass flow controller

Table 2 Abbreviations (continued)

Abbreviation	Definition
MSD	Mass Selective Detector
NCI	Negative CI
OFN	Octafluoronaphthalene (calibrant)
PCI	Positive CI
PFDTD	Perfluoro-5,8-dimethyl-3,6,9-trioxydodecane (calibrant)
PFHT	2,4,6-tris(perfluoroheptyl)-1,3,5-triazine (calibrant)
PFTBA	Perfluorotributylamine (calibrant)
Quad	Quadrupole mass filter
RF	Radio frequency
RFPA	Radio frequency power amplifier
Torr	Unit of pressure, 1 mm Hg
Turbo	Turbomolecular (pump)

The 5975 Series MSD

The 5975 Series MSD is a stand-alone capillary GC detector for use with an Agilent Series Gas Chromatograph (Table 3). The MSD features:

- Local Control Panel (LCP) for locally monitoring and operating the MSD
- One of three different high vacuum pumps
- Rotary vane foreline pump
- Independently MSD heated electron-ionization ion source
- Independently MSD heated hyperbolic quadrupole mass filter
- High-energy dynode (HED) electron multiplier detector
- Independently GC heated GC/MSD interface
- Chemical ionization (EI/PCI/NCI) modes available

Physical description

The 5975 Series MSD is a rectangular box, approximately 42 cm high, 26 cm wide, and 65 cm deep. The weight is 25 kg for the diffusion pump mainframe, 26 kg for the standard turbo pump mainframe, and 29 kg for the performance turbo pump mainframe. The attached foreline (roughing) pump weighs an additional 11 kg (standard pump).

The basic components of the instrument are: the frame/cover assemblies, the local control panel, the vacuum system, the GC interface, the electronics, and the analyzer.

Local control panel

The local control panel allows local monitoring and operation of the MSD. You can tune the MSD, run a method or a sequence, and monitor instrument status.

Vacuum gauge

The 5975 Series MSD may be equipped with a Micro-Ion Vacuum Gauge. The MSD ChemStation can be used to read the pressure (high vacuum) in the vacuum manifold. Operation of the gauge controller is described in this manual.

The gauge is required for chemical ionization (CI) operation.

Table 3 5975 series MSD models and features

Feature	Model			
	G3170A G3175A	G3171A G3176A	G3172A	G3174A
High vacuum pump	Diffusion	Standard turbo	Performance turbo	Performance turbo
Optimal He column flow mL/min	1	1	1 to 2	1 to 2
Maximum recommended gas flow mL/min*	1.5	2.0	4.0	4
Maximum gas flow, mL/min [†]	2	2.4	6.5	6.5
Max column id	0.25 mm (30 m)	0.32 mm (30 m)	0.53 mm (30 m)	0.53 mm (30 m)
CI capability	No	No	No	Yes
DIP [‡] capability (3rd party)	Yes	Yes	Yes	Yes

* Total gas flow into the MSD: column flow plus reagent gas flow (if applicable).

† Expect degradation of spectral performance and sensitivity.

‡ Direct insertion probe.

CI MSD Hardware Description

Figure 1 is an overview of a typical 5975 GC/MSD system.

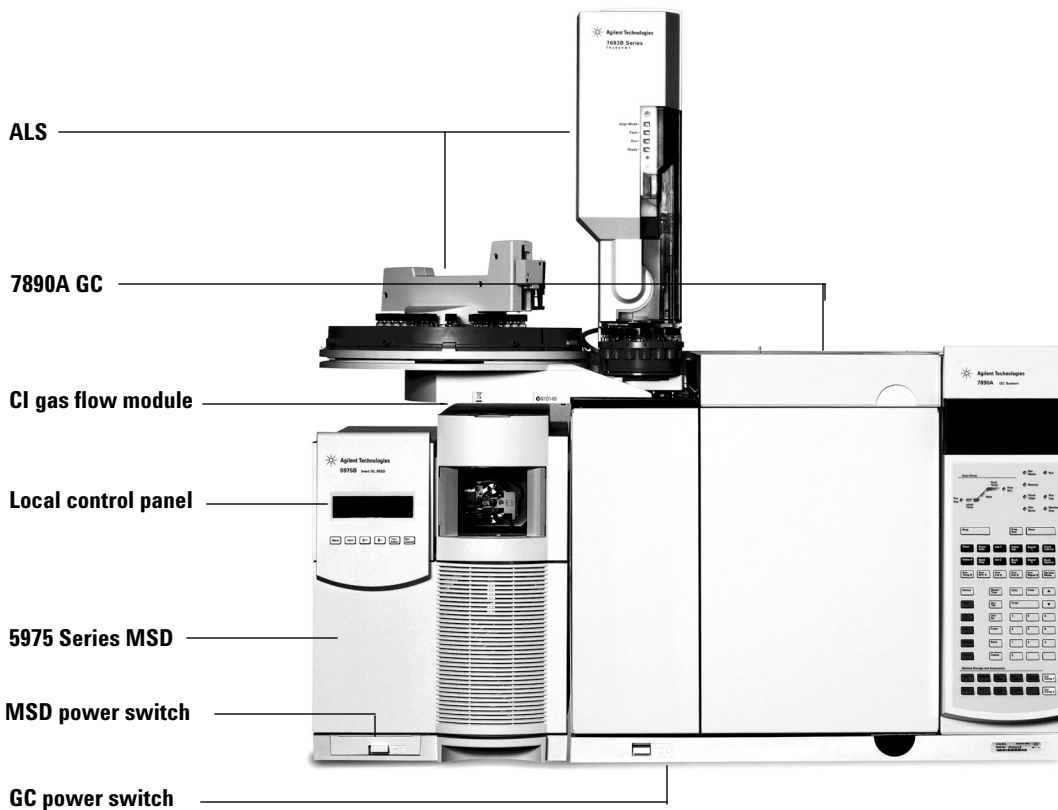

Figure 1 5975 Series GC/MSD system

The CI hardware allows the 5975 Series MSD to produce high-quality, classical CI spectra, which include molecular adduct ions. A variety of reagent gases can be used.

In this manual, the term “CI MSD” refers to the G3174A MSD and upgraded G3172A MSDs. It also applies, unless otherwise specified, to the flow modules for these instruments.

The 5975 Series CI system adds to the 5975 Series MSD:

- EI/CI GC/MSD interface
- CI ion source and interface tip seal
- Reagent gas flow control module
- Bipolar HED power supply for PCI and NCI operation

A methane/isobutane gas purifier is provided and is **required**. It removes oxygen, water, hydrocarbons, and sulfur compounds.

A high vacuum gauge controller (G3397A) is required for CI MSD and is recommended for EI also.

The MSD CI system has been optimized to achieve the relatively high source pressure required for CI while still maintaining high vacuum in the quadrupole and detector. Special seals along the flow path of the reagent gas and very small openings in the ion source keep the source gases in the ionization volume long enough for the appropriate reactions to occur.

The CI interface has special plumbing for reagent gas. A spring-loaded insulating seal fits onto the tip of the interface.

Switching back and forth between CI and EI sources takes less than an hour, although a 1- to 2-hour wait is required to purge the reagent gas lines and bake out water and other contaminants. Switching from PCI to NCI requires about 2 hours for the ion source to cool.

Important Safety Warnings

There are several important safety notices to always keep in mind when using the MSD.

Many internal parts of the MSD carry dangerous voltages

If the MSD is connected to a power source, even if the power switch is off, potentially dangerous voltages exist on:

- The wiring between the MSD power cord and the AC power supply, the AC power supply itself, and the wiring from the AC power supply to the power switch.

With the power switch on, potentially dangerous voltages also exist on:

- All electronics boards in the instrument.
- The internal wires and cables connected to these boards.
- The wires for any heater (oven, detector, inlet, or valve box).

WARNING

All these parts are shielded by covers. With the covers in place, it should be difficult to accidentally make contact with dangerous voltages. Unless specifically instructed to, never remove a cover unless the detector, inlet, or oven are turned off.

WARNING

If the power cord insulation is frayed or worn, the cord must be replaced. Contact your Agilent service representative.

Electrostatic discharge is a threat to MSD electronics

The printed circuit boards in the MSD can be damaged by electrostatic discharge. Do not touch any of the boards unless it is absolutely necessary. If you must handle them, wear a grounded wrist strap and take other antistatic precautions. Wear a grounded wrist strap any time you must remove the MSD right side cover.

Many parts are dangerously hot

Many parts of the GC/MSD operate at temperatures high enough to cause serious burns. These parts include but are not limited to:

- The inlets
- The oven and its contents
- The detector
- The column nuts attaching the column to an inlet or detector
- The valve box
- The foreline pump

Always cool these areas of the system to room temperature before working on them. They will cool faster if you first set the temperature of the heated zone to room temperature. Turn the zone off after it has reached the setpoint. If you must perform maintenance on hot parts, use a wrench and wear gloves. Whenever possible, cool the part of the instrument that you will be maintaining before you begin working on it.

WARNING

Be careful when working behind the instrument. During cool-down cycles, the GC emits hot exhaust which can cause burns.

WARNING

The insulation around the inlets, detectors, valve box, and the insulation cups is made of refractory ceramic fibers. To avoid inhaling fiber particles, we recommend the following safety procedures: ventilate your work area; wear long sleeves, gloves, safety glasses, and a disposable dust/mist respirator; dispose of insulation in a sealed plastic bag; wash your hands with mild soap and cold water after handling the insulation.

The oil pan under the standard foreline pump can be a fire hazard

Oily rags, paper towels, and similar absorbents in the oil pan could ignite and damage the pump and other parts of the MSD.

WARNING

Combustible materials (or flammable/non-flammable wicking material) placed under, over, or around the foreline (roughing) pump constitutes a fire hazard. Keep the pan clean, but do not leave absorbent material such as paper towels in it.

Hydrogen Safety

WARNING

The use of hydrogen as a GC carrier gas is potentially dangerous.

WARNING

When using hydrogen (H₂) as the carrier gas or fuel gas, be aware that hydrogen gas can flow into the GC oven and create an explosion hazard. Therefore, be sure that the supply is turned off until all connections are made and ensure that the inlet and detector column fittings are either connected to a column or capped at all times when hydrogen gas is supplied to the instrument.

Hydrogen is flammable. Leaks, when confined in an enclosed space, may create a fire or explosion hazard. In any application using hydrogen, leak test all connections, lines, and valves before operating the instrument. Always turn off the hydrogen supply at its source before working on the instrument.

Hydrogen is a commonly used GC carrier gas. Hydrogen is potentially explosive and has other dangerous characteristics.

- Hydrogen is combustible over a wide range of concentrations. At atmospheric pressure, hydrogen is combustible at concentrations from 4% to 74.2% by volume.
- Hydrogen has the highest burning velocity of any gas.
- Hydrogen has a very low ignition energy.
- Hydrogen that is allowed to expand rapidly from high pressure can self-ignite.
- Hydrogen burns with a nonluminous flame which can be invisible under bright light.

GC precautions

When using hydrogen as a carrier gas, remove the large round plastic cover for the MSD transfer line located on the GC left side panel. In the unlikely event of an explosion, this cover may dislodge.

Dangers unique to GC/MSD operation

Hydrogen presents a number of dangers. Some are general, others are unique to GC or GC/MSD operation. Dangers include, but are not limited to:

- Combustion of leaking hydrogen.
- Combustion due to rapid expansion of hydrogen from a high-pressure cylinder.
- Accumulation of hydrogen in the GC oven and subsequent combustion (see your GC documentation and the label on the top edge of the GC oven door).
- Accumulation of hydrogen in the MSD and subsequent combustion.

Hydrogen accumulation in an MSD

WARNING

The MSD cannot detect leaks in inlet and/or detector gas streams. For this reason, it is vital that column fittings should always be either connected to a column or have a cap or plug installed.

All users should be aware of the mechanisms by which hydrogen can accumulate (Table 4) and know what precautions to take if they know or suspect that hydrogen has accumulated. Note that these mechanisms apply to *all* mass spectrometers, including the MSD.

Table 4 Hydrogen accumulation mechanisms

Mechanism	Results
Mass spectrometer turned off	A mass spectrometer can be shut down deliberately. It can also be shut down accidentally by an internal or external failure. A mass spectrometer shutdown does not shut off the flow of carrier gas. As a result, hydrogen may slowly accumulate in the mass spectrometer.

Table 4 Hydrogen accumulation mechanisms (continued)

Mechanism	Results
Mass spectrometer automated shutoff valves closed	Some mass spectrometers are equipped with automated diffusion pump shutoff valves. In these instruments, deliberate operator action or various failures can cause the shutoff valves to close. Shutoff valve closure does not shut off the flow of carrier gas. As a result, hydrogen may slowly accumulate in the mass spectrometer.
Mass spectrometer manual shutoff valves closed	Some mass spectrometers are equipped with manual diffusion pump shutoff valves. In these instruments, the operator can close the shutoff valves. Closing the shutoff valves does not shut off the flow of carrier gas. As a result, hydrogen may slowly accumulate in the mass spectrometer.
GC off	A GC can be shut down deliberately. It can also be shut down accidentally by an internal or external failure. Different GCs react in different ways. If a 6890 GC equipped with Electronic Pressure Control (EPC) is shut off, the EPC stops the flow of carrier gas. If the carrier flow is not under EPC control, the flow increases to its maximum. This flow may be more than some mass spectrometers can pump away, resulting in the accumulation of hydrogen in the mass spectrometer. If the mass spectrometer is shut off at the same time, the accumulation can be fairly rapid.
Power failure	If the power fails, both the GC and mass spectrometer shut down. The carrier gas, however, is not necessarily shut down. As described previously, in some GCs a power failure may cause the carrier gas flow to be set to maximum. As a result, hydrogen may accumulate in the mass spectrometer.

WARNING

Once hydrogen has accumulated in a mass spectrometer, extreme caution must be used when removing it. Incorrect startup of a mass spectrometer filled with hydrogen can cause an explosion.

WARNING

After a power failure, the mass spectrometer may start up and begin the pumpdown process by itself. This does not guarantee that all hydrogen has been removed from the system or that the explosion hazard has been removed.

Precautions

Take the following precautions when operating a GC/MSD system with hydrogen carrier gas.

Equipment precaution

You **MUST** make sure the front side-plate thumbscrew is fastened finger-tight. Do not overtighten the thumbscrew; it can cause air leaks.

WARNING

Failure to secure your MSD as described above greatly increases the chance of personal injury in the event of an explosion.

You must remove the plastic cover over the glass window on the front of a 5975 MSD. In the unlikely event of an explosion, this cover may dislodge.

General laboratory precautions

- Avoid leaks in the carrier gas lines. Use leak-checking equipment to periodically check for hydrogen leaks.
- Eliminate from your laboratory as many ignition sources as possible (open flames, devices that can spark, sources of static electricity, etc.).
- Do not allow hydrogen from a high pressure cylinder to vent directly to atmosphere (danger of self-ignition).
- Use a hydrogen generator instead of bottled hydrogen.

Operating precautions

- Turn off the hydrogen at its source every time you shut down the GC or MSD.
- Turn off the hydrogen at its source every time you vent the MSD (do not heat the capillary column without carrier gas flow).
- Turn off the hydrogen at its source every time shutoff valves in an MSD are closed (do not heat the capillary column without carrier gas flow).
- Turn off the hydrogen at its source if a power failure occurs.
- If a power failure occurs while the GC/MSD system is unattended, even if the system has restarted by itself:
 - 1 Immediately turn off the hydrogen at its source.
 - 2 Turn off the GC.
 - 3 Turn off the MSD and allow it to cool for 1 hour.
 - 4 Eliminate **all** potential sources of ignition in the room.
 - 5 Open the vacuum manifold of the MSD to atmosphere.
 - 6 Wait at least 10 minutes to allow any hydrogen to dissipate.
 - 7 Start up the GC and MSD as normal.

When using hydrogen gas, check the system for leaks to prevent possible fire and explosion hazards based on local Environmental Health and Safety (EHS) requirements. Always check for leaks after changing a tank or servicing the gas lines. Always make sure the vent line is vented into a fume hood.

Safety and Regulatory Certifications

The 5975 Series MSD conforms to the following safety standards:

- Canadian Standards Association (CSA): CAN/CSA-C222 No. 61010-1-04
- CSA/Nationally Recognized Test Laboratory (NRTL): UL 61010-1
- International Electrotechnical Commission (IEC): 61010-1
- EuroNorm (EN): 61010-1

The 5975 MSD conforms to the following regulations on Electromagnetic Compatibility (EMC) and Radio Frequency Interference (RFI):

- CISPR 11/EN 55011: Group 1, Class A
- IEC/EN 61326
- AUS/NZ 

This ISM device complies with Canadian ICES-001. Cet appareil ISM est conforme a la norme NMB-001 du Canada.



The 5975 Series MSD is designed and manufactured under a quality system registered to ISO 9001.

Information











The Agilent Technologies 5975 Series MSD meets the following IEC (International Electro-technical Commission) classifications: Equipment Class I, Laboratory Equipment, Installation Category II, Pollution Degree 2.

This unit has been designed and tested in accordance with recognized safety standards and is designed for use indoors. If the instrument is used in a manner not specified by the manufacturer, the protection provided by the instrument may be impaired. Whenever the safety protection of the MSD has been compromised, disconnect the unit from all power sources and secure the unit against unintended operation.

Refer servicing to qualified service personnel. Substituting parts or performing any unauthorized modification to the instrument may result in a safety hazard.

Symbols

Warnings in the manual or on the instrument must be observed during all phases of operation, service, and repair of this instrument. Failure to comply with these precautions violates safety standards of design and the intended use of the instrument. Agilent Technologies assumes no liability for the customer's failure to comply with these requirements.

See accompanying instructions for more information.	
Indicates a hot surface.	
Indicates hazardous voltages.	
Indicates earth (ground) terminal.	
Indicates potential explosion hazard.	 or 
Indicates radioactivity hazard.	
Indicates electrostatic discharge hazard.	
Indicates that you must not discard this electrical/electronic product in domestic household waste.	 

Electromagnetic compatibility

This device complies with the requirements of CISPR 11. Operation is subject to the following two conditions:

- This device may not cause harmful interference.
- This device must accept any interference received, including interference that may cause undesired operation.

If this equipment does cause harmful interference to radio or television reception, which can be determined by turning the equipment off and on, the user is encouraged to try one or more of the following measures:

- 1 Relocate the radio or antenna.
- 2 Move the device away from the radio or television.
- 3 Plug the device into a different electrical outlet, so that the device and the radio or television are on separate electrical circuits.
- 4 Make sure that all peripheral devices are also certified.
- 5 Make sure that appropriate cables are used to connect the device to peripheral equipment.
- 6 Consult your equipment dealer, Agilent Technologies, or an experienced technician for assistance.
- 7 Changes or modifications not expressly approved by Agilent Technologies could void the user's authority to operate the equipment.

Sound emission declaration

Sound pressure

Sound pressure $L_p < 70$ dB according to EN 27779:1991.

Schalldruckpegel

Schalldruckpegel $L_P < 70$ dB am nach EN 27779:1991.

Cleaning/Recycling the Product

To clean the unit, disconnect the power and wipe down with a damp, lint-free cloth. For recycling, contact your local Agilent sales office.

Liquid Spillage

Do not spill liquids on the MSD.

Moving or Storing the MSD

The best way to keep your MSD functioning properly is to keep it pumped down and hot, with carrier gas flow. If you plan to move or store your MSD, a few additional precautions are required. The MSD must remain upright at all times; this requires special caution when moving. The MSD should not be left vented to atmosphere for long periods.

1 Introduction

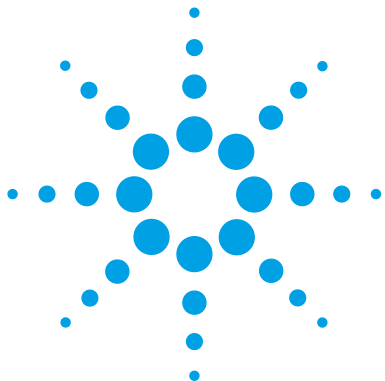

2 Installing GC Columns

Columns	30
Conditioning columns	30
Conditioning ferrules	31
Tips and hints	31
To reconfigure a 6850 GC column on its basket	32
To prepare a capillary column for installation	37
To install a capillary column in a split/splitless inlet	39
To condition a capillary column	41
To install a capillary column in the GC/MSD interface	43

Before you can operate your GC/MSD system, you must select, install, and condition a GC column. This chapter will show you how to install and condition a column. For correct column and flow selection, you must know what type of vacuum system your MSD has. The serial number tag on the lower front of the left side panel shows the model number.



Columns

Many types of GC columns can be used with the MSD but there are some restrictions.

During tuning or data acquisition the rate of column flow into the MSD should not exceed the maximum recommended flow. Therefore, there are limits to column length and flow. Exceeding recommended flow will result in degradation of mass spectral and sensitivity performance.

Remember that column flows vary greatly with oven temperature. See [“To measure column flow linear velocity”](#) for instructions on how to measure actual flow in your column. Use the Flow Calculation software and [Table 5](#) to determine whether a given column will give acceptable flow with realistic head pressure.

Table 5 Gas flows

Feature	G3170A G3175A	G3171A G3176A	G3172A	G3174A
High vacuum pump	Diffusion	Standard turbo	Performance turbo	Performance turbo
Optimal gas flow, mL/min*	1	1	1 to 2	1 to 2
Maximum recommended gas flow, mL/min	1.5	2	4	4
Maximum gas flow, mL/min†	2	2.4	6.5	6.5
Maximum column id	0.25 mm (30 m)	0.32 mm (30 m)	0.53 mm (30 m)	0.53 mm (30 m)

* Total gas flow into the MSD = column flow + reagent gas flow (if applicable)

† Expect degradation of spectral performance and sensitivity.

Conditioning columns



Conditioning a column before it is connected to the GC/MSD interface is essential.

A small portion of the capillary column stationary phase is often carried away by the carrier gas. This is called column bleed. Column bleed deposits traces of the stationary phase in the MSD ion source. This decreases MSD sensitivity and makes cleaning the ion source necessary.

Column bleed is most common in new or poorly crosslinked columns. It is much worse if there are traces of oxygen in the carrier gas when the column is heated. To minimize column bleed, all capillary columns should be conditioned before they are installed in the GC/MSD interface.

Conditioning ferrules

Heating ferrules to their maximum expected operating temperature a few times before they are installed can reduce chemical bleed from the ferrules.

Tips and hints

- The column installation procedures for the 5975 Series MSDs is different from that for previous MSDs. Using the procedure from another instrument may not work and may damage the column or the MSD.
- You can remove old ferrules from column nuts with an ordinary push pin.
- Always use carrier gas that is at least 99.9995% pure.
- Because of thermal expansion, new ferrules may loosen after heating and cooling a few times. Check for tightness after two or three heating cycles.
- Always wear clean gloves when handling columns, especially the end that will be inserted into the GC/MSD interface.

WARNING

If you are using hydrogen as a carrier gas, do not start carrier gas flow until the column is installed in the MSD and the MSD has been pumped down. If the vacuum pumps are off, hydrogen will accumulate in the MSD and an explosion may occur. See “Hydrogen Safety” .

WARNING

Always wear safety glasses when handling capillary columns. Use care to avoid puncturing your skin with the end of the column.

To reconfigure a 6850 GC column on its basket

Before installing a 6850, first reconfigure it to better position the column ends for installation in the GC MSD interface.

- 1 Lay the column (19091S-433E found in the GC ship kit) on a clean surface with the column label facing the user in the 12 o'clock position. Note that the inlet and outlet ends of the column are oriented the same as when a GC detector is used and the column outlet is positioned at the back (closer to the fan) of the column cage holder. See [Figure 2](#).

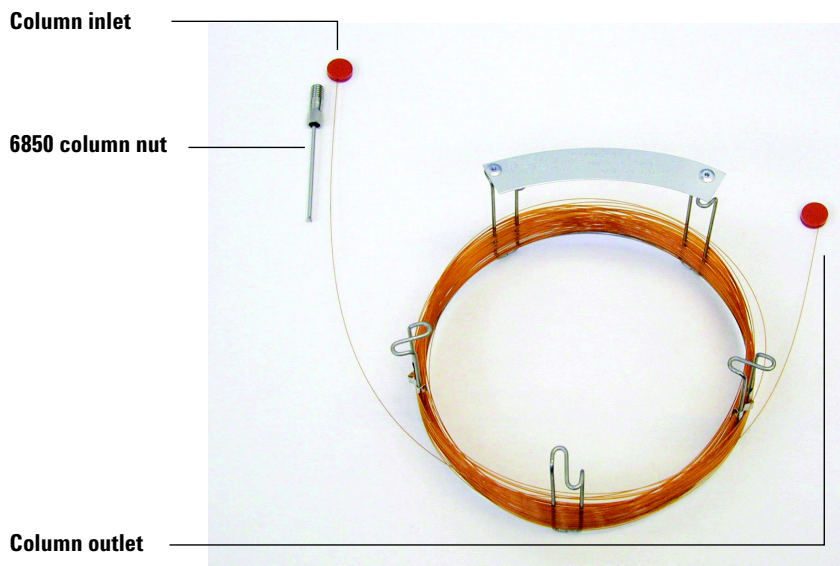

Figure 2 Column

- 2 Remove the septum cap from the column OUTLET side and uncoil 2 column loops. See [Figure 3](#).

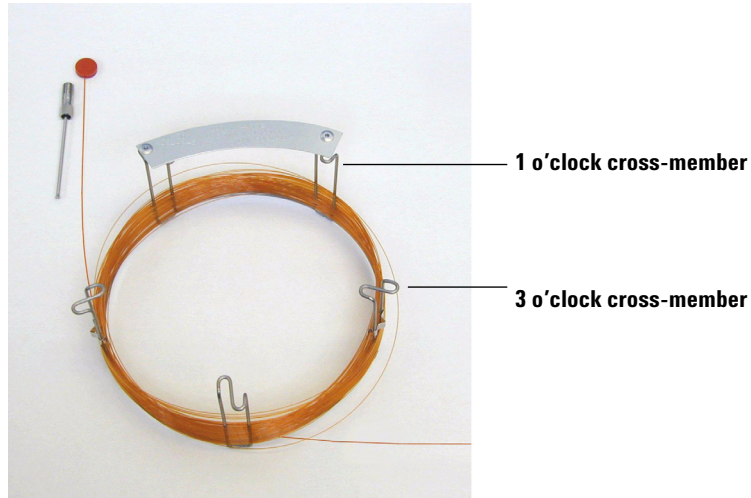

Figure 3 Column with 2 uncoiled loops

- 3 Attach three column clips (part number G2630-20890) to the column cage as follows:
 - Attach one clip onto the back of the 1 o'clock cross-member piece of the column cage.
 - Attach two clips onto the front of the 3 o'clock cross-member piece of the column cage.

These clips will help provide appropriate orientation of column ends for their insertion into the GC inlet and MSD interface.

2 Installing GC Columns

See Figure 4.

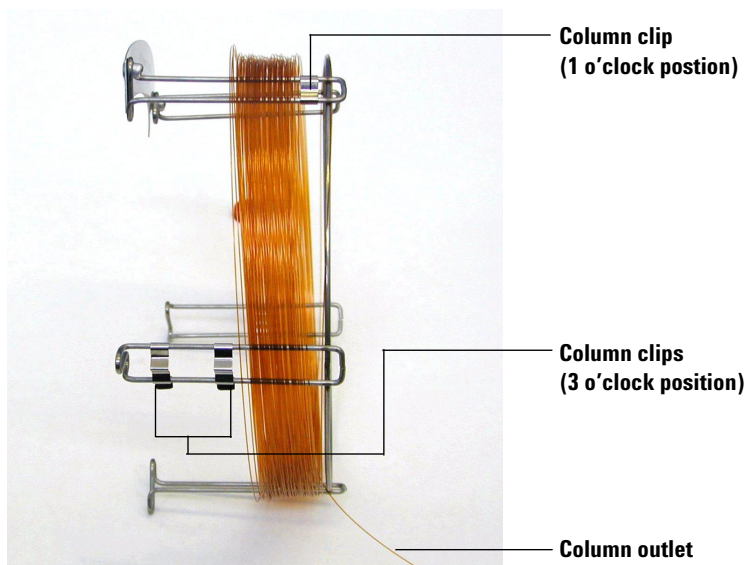

Figure 4 Column with column clips attached

- 4 Feed the outlet side of the column through the 1 o'clock positioned clip so that the column outlet is pointing toward the front of the column cage. See [Figure 5](#).

CAUTION

Be careful not to scratch the column coating.

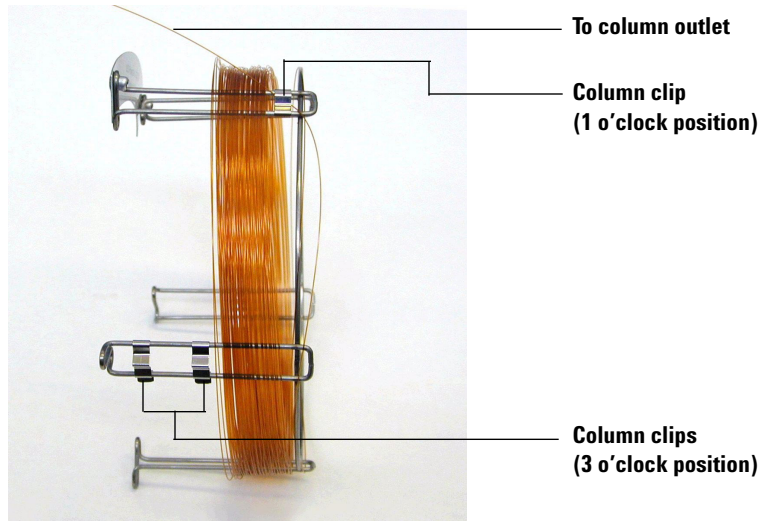

Figure 5 Column fed through 1 o'clock position

- 5 Next, feed the outlet side of the column through the 3 o'clock positioned clips so that the column outlet is pointing toward the back of the column cage. Make sure that the part of the column that is between the two clips does NOT extend above the column label. See [Figure 6](#).

CAUTION

Be careful not to scratch the column coating.

2 Installing GC Columns

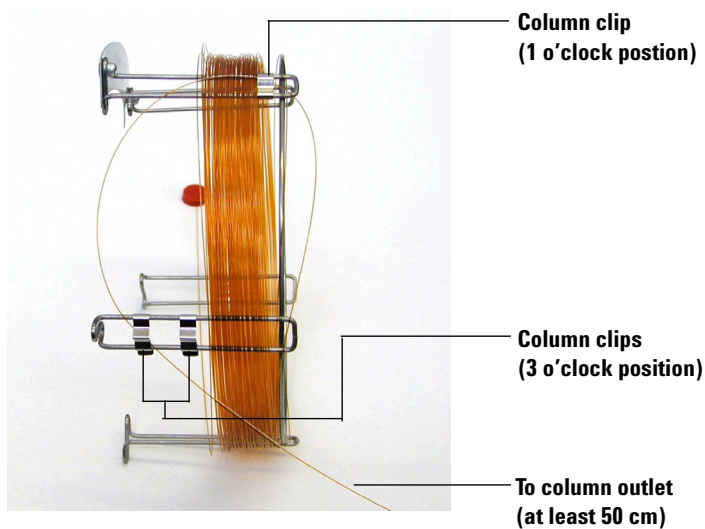

Figure 6 Column fed through 3 o'clock position

There should be approximately 50 cm of column extending beyond the 3 o'clock positioned clip.

- 6** Carefully rewind the remainder of the column outlet end around the column cage.

To prepare a capillary column for installation

Materials needed

- Capillary column
- Column cutter, ceramic (5181-8836) or diamond (5183-4620)
- Ferrules
 - 0.27-mm id, for 0.10-mm id columns (5062-3518)
 - 0.37-mm id, for 0.20-mm id columns (5062-3516)
 - 0.40-mm id, for 0.25-mm id columns (5181-3323)
 - 0.5-mm id, for 0.32-mm id columns (5062-3514)
 - 0.8-mm id, for 0.53-mm id columns (5062-3512)
- Gloves, clean
 - Large (8650-0030)
 - Small (8650-0029)
- Inlet column nut (5181-8830 for Agilent 7890A, 7820A and 6890, or 5183-4732 for 6850)
- Magnifying loupe
- Septum (may be old, used inlet septum)

Procedure

- 1 Slide a septum, column nut, and conditioned ferrule onto the free end of the column ([Figure 7](#)). The tapered end of the ferrule should point away from the column nut.

2 Installing GC Columns

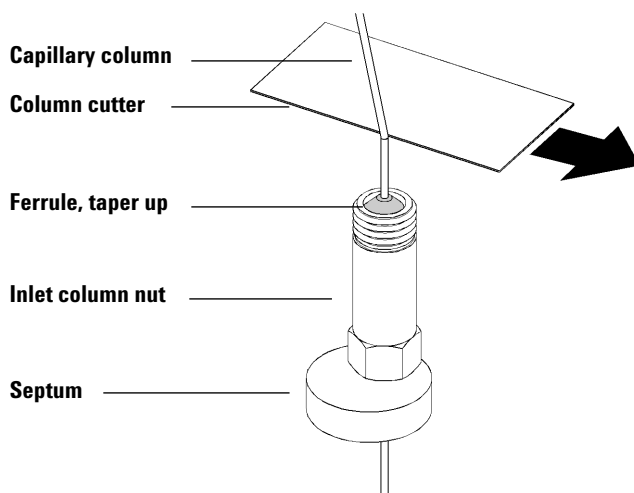

Figure 7 Preparing a capillary column for installation

- 2 Use the column cutter to score the column 2 cm from the end.
- 3 Break off the end of the column. Hold the column against the column cutter with your thumb. Break the column against the edge of the column cutter.
- 4 Inspect the end for jagged edges or burrs. If the break is not clean and even, repeat steps 2 and 3.
- 5 Wipe the outside of the free end of the column with a lint-free cloth moistened with methanol.

To install a capillary column in a split/splitless inlet

Materials needed

- Gloves, clean
 - Large (8650-0030)
 - Small (8650-0029)
- Metric ruler
- Wrench, open-end, 1/4-inch and 5/16-inch (8710-0510)

To install columns in other types of inlets, refer to your Gas Chromatograph User Information.

Procedure



- 1 Prepare the column for installation (“To prepare a capillary column for installation” on page 37).
- 2 Position the column so it extends 4 to 6 mm past the end of the ferrule (Figure 8).

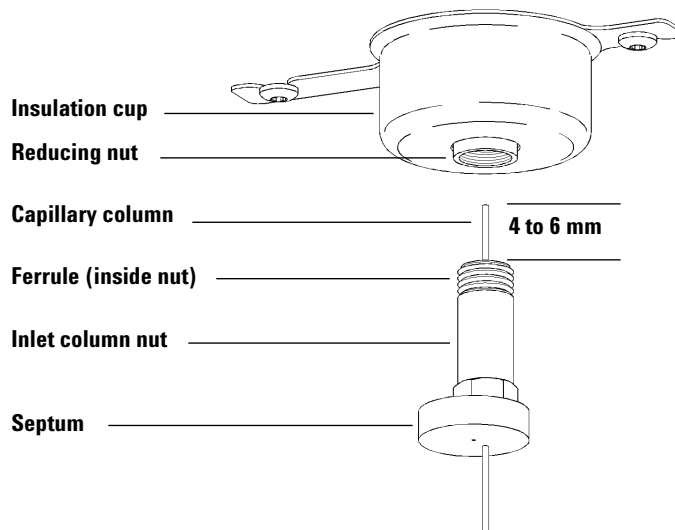

Figure 8 Installing a capillary column for a split/splitless inlet

2 Installing GC Columns

- 3 Slide the septum to place the nut and ferrule in the correct position.
- 4 Insert the column in the inlet.
- 5 Slide the nut up the column to the inlet base and finger-tighten the nut.
- 6 Adjust the column position so the septum is even with the bottom of the column nut.
- 7 Tighten the column nut an additional 1/4 to 1/2 turn. The column should not slide with a gentle tug.
- 8 Start carrier gas flow.
- 9 Verify flow by submerging the free end of the column in isopropanol. Look for bubbles.

To condition a capillary column

Materials needed

- Carrier gas, (99.9995% pure or better)
- Wrench, open-end, 1/4-inch and 5/16-inch (8710-0510)

WARNING

Do not condition your capillary column with hydrogen. Hydrogen accumulation in the GC oven can result in an explosion. If you plan to use hydrogen as your carrier gas, first condition the column with ultrapure (99.999% or better) inert gas such as helium, nitrogen, or argon.

Procedure



- 1 Install the column in the GC inlet (“To install a capillary column in a split/splitless inlet” on page 39).
- 2 Allow the carrier gas to flow through the column for 5 minutes without heating the GC oven.
- 3 Ramp the oven temperature at 5 °C/minute to 10 °C above your highest analytical temperature.
- 4 Once the oven temperature exceeds 80 °C, inject 5 µL methanol into the GC. Repeat two more times at 5-minute intervals. This helps remove any contamination from the column before it is installed into the GC/MSD interface.

CAUTION

Never exceed the maximum column temperature, either in the GC/MSD interface, the GC oven, or the inlet.

- 5 Hold this temperature. Allow the carrier gas to flow for several hours.
- 6 Return the GC oven temperature to a low standby temperature.

2 Installing GC Columns

See also

For more information about installing a capillary column, refer to the application note *Optimizing Splitless Injections on Your GC for High Performance MS Analysis*, publication number 5988-9944EN.

To install a capillary column in the GC/MSD interface

Agilent 7890A and 7820A, and 6890 GCs

Materials needed

- Column cutter, ceramic (5181-8836) or diamond (5183-4620)
- Ferrules
 - 0.3-mm id, for 0.10-mm id columns (5062-3507)
 - 0.4-mm id, for 0.20- and 0.25-mm id columns (5062-3508)
 - 0.5-mm id, for 0.32-mm id columns (5062-3506)
 - 0.8-mm id, for 0.53-mm id columns (5062-3512)
- Flashlight
- Hand lens (magnifying loupe)
- Gloves, clean
 - Large (8650-0030)
 - Small (8650-0029)
- Interface column nut (05988-20066)
- Safety glasses
- Wrench, open-end, 1/4-inch and 5/16-inch (8710-0510)

CAUTION

Note that the column installation procedure for the 5975 Series MSDs is different from that for most previous MSDs. Using the procedure from another instrument may result in poor sensitivity and possible damage to the MSD.

Procedure

- 1 Condition the column ([page 41](#)).
- 2 Vent the MSD ([page 82](#)) and open the analyzer chamber ([page 84](#)). Be sure you can see the end of the GC/MSD interface.
- 3 If the CI interface is installed, remove the spring-loaded tip seal from the MSD end of the interface.
- 4 Slide an interface nut and conditioned ferrule onto the free end of the GC column. The tapered end of the ferrule must point towards the nut.



2 Installing GC Columns

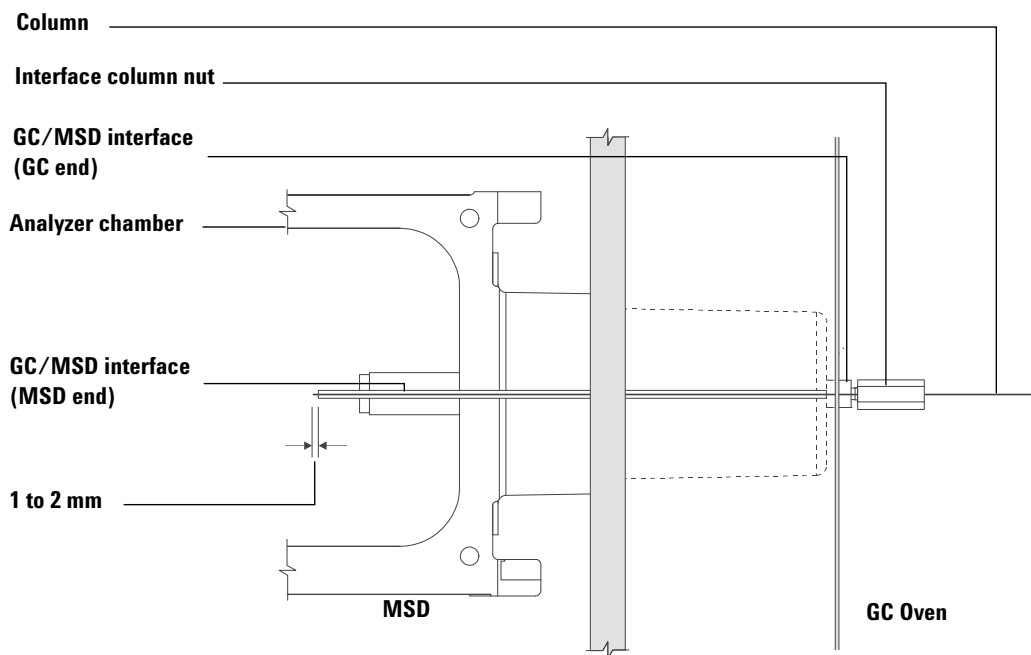

Figure 9 Installing a capillary column in the GC/MSD interface

- 5 Slide the column into the GC/MSD interface (Figure 9) until you can pull it out through the analyzer chamber.
- 6 Break 1 cm off the end of the column (page 32). Do not let any column fragments fall into the analyzer chamber. They could damage the high vacuum pump.
- 7 Clean the outside of the free end of the column with a lint-free cloth moistened with methanol.
- 8 Adjust the column so it projects 1 to 2 mm past the end of the interface.

Use the flashlight and hand lens if necessary to see the end of the column inside the analyzer chamber. Do not use your finger to feel for the column end.

- 9 Hand-tighten the nut. Make sure the position of the column does not change as you tighten the nut. Reinstall the spring-loaded tip seal if it was removed earlier.
- 10 Check the GC oven to be sure that the column does not touch the oven walls.
- 11 Tighten the nut 1/4 to 1/2 turn. Check the tightness after one or two heat cycles.



6850 GC

- 1 Carefully unwind the outlet end of the GC column until the 3 o'clock clip is reached.
- 2 Slide an interface column nut (part number 05988-20066) and ferrule (part number 5062-3508) onto the outlet end of the GC column.

The tapered end of the ferrule must point towards the nut.
- 3 Slide the column into the GC/MSD interface until the column protrudes into the analyzer chamber at least 5 cm.
- 4 Adjust the length of the column from the 3 o'clock clip to the back of the interface column nut to be 22–28 cm. See [Figure 10](#).
- 5 Hand tighten the interface nut.
- 6 Carefully close the oven door while observing to see that the column does not develop sharp bends or touch the oven walls/floor. Try this procedure several times.

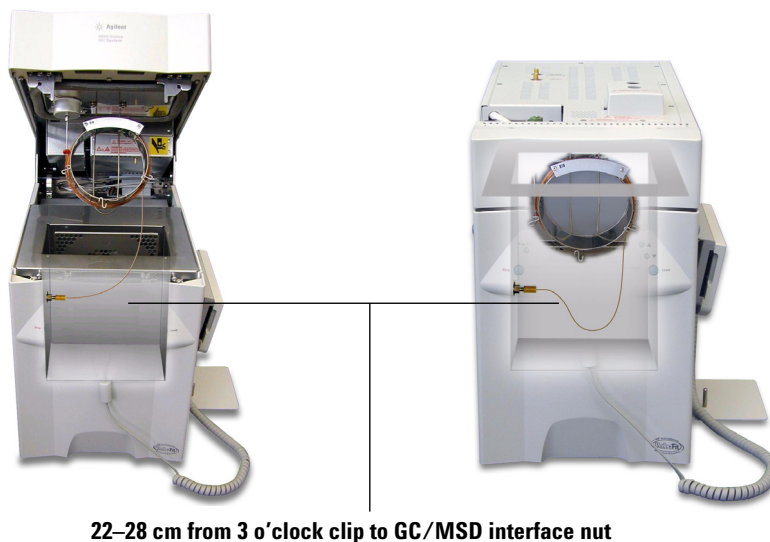

22–28 cm from 3 o'clock clip to GC/MSD interface nut

Figure 10 Oven door opened and closed

- 7** Loosen the interface nut and push the column an additional 3–5 cm into the analyzer chamber.
- 8** Make a clean cut of the column so that now only 3–5 cm protrudes into the analyzer chamber.
- 9** Clean the outside of the free end of the column with a lint-free cloth moistened with methanol.
- 10** Adjust the column so that it protrudes 1 to 2 mm into the analyzer chamber past the end of the GC/MSD interface, and hand tighten the nut. See [Figure 11](#).

Make sure the position of the column does not change as you retighten the nut.

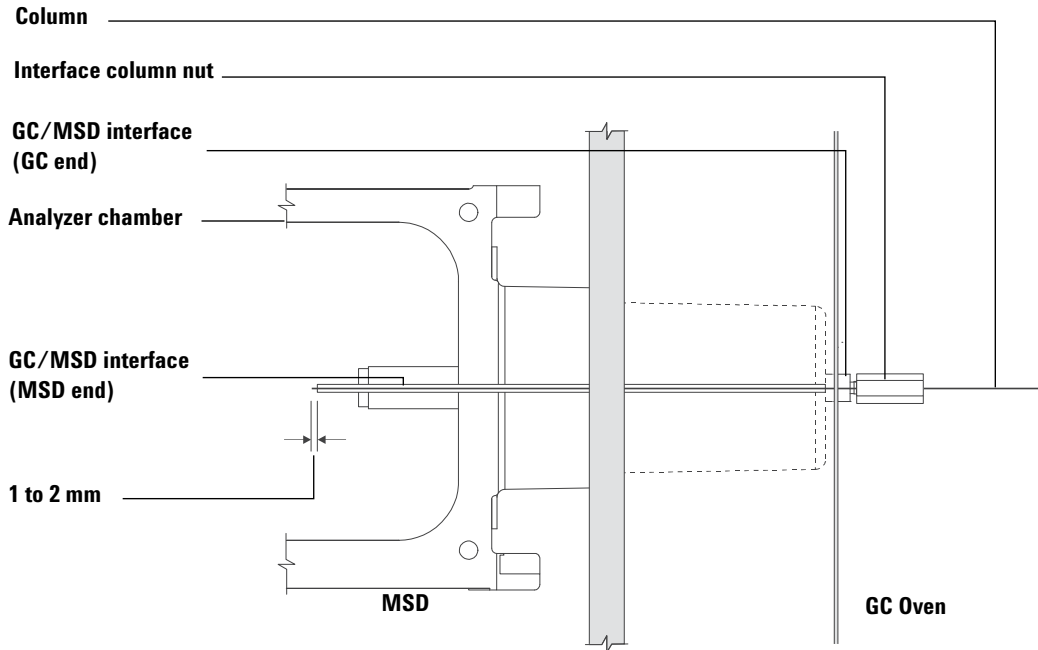
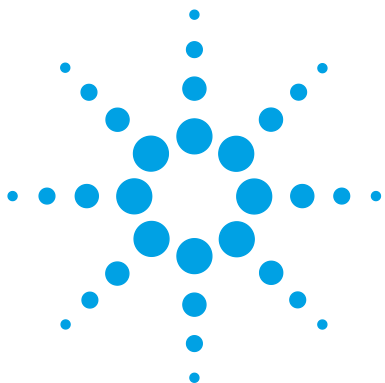

Figure 11 MSD - GC column connection

- 11** Repeat [step 6](#) to assure column integrity.
- 12** Tighten the interface nut an additional 1/4 to 1/2 turn with a 1/4-inch open-end wrench.
Check the tightness after one or two heat cycles.
- 13** Turn the GC on.
- 14** Verify that the inlet temperature is set to 25 °C.
- 15** Close the analyzer side plate, then reconnect the source power and side board control cables.
- 16** Turn on the MSD power switch to initiate MSD pump down.
Press on the side plate of the MSD to achieve a good seal. Verify that the foreline pump and front fan turn on and that the foreline pump stops gurgling within 60 seconds.

2 Installing GC Columns

17 Reinstall the MSD analyzer cover.



3

Operating in Electron Impact (EI) Mode

Operating the MSD from the Data System	51
Operating the MSD from the LCP	51
LCP Status Messages	53
LCP Menus	55
The EI GC/MSD Interface	58
Before You Turn On the MSD	60
Pumping Down	61
Controlling Temperatures	61
Controlling Column Flow	62
Venting the MSD	63
To view MSD analyzer temperature and vacuum status	64
To set monitors for MSD temperature and vacuum status	66
To set the MSD analyzer temperatures	67
To set the GC/MSD interface temperature from the ChemStation	69
To monitor high vacuum pressure	71
To measure column flow linear velocity	73
To confirm column flow	74
To tune the MSD	75
To verify system performance	76
High-Mass Testing (5975 Series MSDs)	77
To remove the MSD covers	80
To vent the MSD	82
To open the analyzer chamber	84
To close the analyzer chamber	87
To pump down the MSD	91
To move or store the MSD	93
To set the interface temperature from the GC	95



3 Operating in Electron Impact (EI) Mode

How to perform some basic operating procedures for the MSD.

CAUTION

The software and firmware are revised periodically. If the steps in these procedures do not match your MSD ChemStation software, refer to the manuals and online help supplied with the software for more information.

Operating the MSD from the Data System

The software performs tasks such as pumping down, monitoring pressures, setting temperatures, tuning, and preparing to vent. These tasks are described in this chapter. Data acquisition and data analysis are described in the manuals and online help supplied with the MSD ChemStation software.

Operating the MSD from the LCP

The local control panel (LCP) shows the status of the MSD or initiates a task on the MSD without using the Agilent GC/MSD ChemStation.

The GC/MSD ChemStation may be located anywhere on the site local area network (LAN), so the GC/MSD ChemStation might not be near the instrument itself. And because the LCP communicates with the GC/MSD ChemStation via the LAN, you can access GC/MSD ChemStation software functions, such as tuning and starting a run, right from the MSD.

NOTE

Only certain functions are available from the LCP; the GC/MSD ChemStation is the full-featured controller for most instrument control operations.

Modes of operation

The LCP has two modes of operation: Status and Menu.

Status mode requires no interaction and simply displays the current status of the MSD instrument or its various communication connections. If you select [**Menu**], then [**No/Cancel**], you will be returned to the Status mode.

Menu mode allows you to query various aspects of the GC/MSD and to initiate some actions like running a method or sequence or preparing to vent the system.

To access a particular menu option:

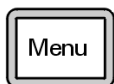

Press [**Menu**] until the desired menu appears.



Press [**Item**] until the desired menu item appears.

3 Operating in Electron Impact (EI) Mode

Use one or more of the following keys as appropriate to respond to prompts or select options:

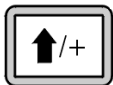

Use [**Up**] to increase the displayed value or to scroll up (such as in a message list).

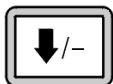

Use [**Down**] to decrease the displayed value or to scroll down (such as in a message list).

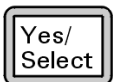

Use [**Yes/Select**] to accept the current value.



Use [**No/Cancel**] to return to the Status mode.

After you make your selection, or if you cycle through all available menus, the display automatically returns to Status mode.

Pressing [**Menu**], then [**No/Cancel**], will always display the Status mode.

Pressing [**No/Cancel**] twice will always return to the Status mode.

LCP Status Messages

The following messages may be displayed on the LCP to inform you of the status of the MSD system. If the LCP is currently in Menu mode, cycle through the menus to return to Status mode.

NOTE

No messages will be displayed if an online instrument session is not currently running on the GC/MSD ChemStation.

ChemStation Loading <timestamp>

The Agilent MSD Productivity ChemStation software is starting up.

Executing <type>tune

A tuning procedure is in progress (type = QuickTune or Autotune).

Instrument Available <timestamp>

The Agilent MSD Productivity ChemStation software is not running.

Loading Method <method name>

Method parameters are being sent to the MSD.

Loading MSD Firmware

The MSD's firmware is being initialized.

The following messages alternately appear on the LCP if the MSD does *NOT* complete its bootup sequence properly:

Server not Found
Check LAN Connection

Seeking Server
Bootp Query xxx

These messages indicate that the MSD has not received its unique IP address from the Agilent Bootp Service. If the messages persist after you have logged onto your account on the GC/MSD ChemStation, consult the Troubleshooting section of the Software Installation manual.

Loading OS

The operating system of the instrument controller is being initialized.

<method> Complete <timestamp>

The run and subsequent data processing are done. The same message appears even if the run was terminated prematurely.

Method Loaded <method name>

Method parameters were sent to the MSD.

MS locked by <computer name>

MS parameters can only be changed from the GC/MSD ChemStation.

Press Sideplate

A reminder during startup to press the MSD sideplate to ensure an adequate vacuum seal.

Run: <method> Acquiring <datafile>

A run is in progress; data is being acquired to the designated data file.

To view system status during startup

- 1 The following messages are displayed on the LCP display during startup:
 - **Press sideplate**
 - **Loading OS**
 - **Press sideplate**
 - **Loading MSD Firmware**
- 2 Continue to press the sideplate of the MSD until the **MSD Ready** message appears. This helps the instrument to pump down more quickly.

LCP Menus

To access a particular menu option, press [**Menu**] until the desired menu appears, then press [**Item**] until the desired menu item appears. [Table 6](#) through [Table 11](#) list the menus and selections.

NOTE

Many menu items, especially on the ChemStation, MS Parameters, and Maintenance menus, have no effect when the instrument is acquiring data.

Table 6 ChemStation menu

Action	Description
Run Method	Displays the current method name and starts an analysis.
Run Sequence	Displays the current sequence and starts a sequence.
Run Current Tune	Displays the current tune file and starts an autotune (EI mode only; CI tune must be started from the GC/MSD ChemStation).
# of Messages	Displays the number of messages and the text of the most recent message. Use the arrow keys to scroll through previous messages (up to 20).
Release ChemStation	Disassociates the GC/MSD ChemStation from the MSD.
Connection Status	Displays the LAN connection status for the MSD. Remote = connected to GC/MSD ChemStation online session Local = not connected to GC/MSD ChemStation online session
Name of Instrument	Displays the name of the instrument if connected to GC/MSD ChemStation online session. The name of the instrument is the name assigned to the MSD by the GC/MSD ChemStation Configuration dialogue.

3 Operating in Electron Impact (EI) Mode

Table 7 Maintenance menu

Action	Description
Prepare to vent	Reminds you to shut down the GC then prepares the instrument for venting when [Yes/Select] is pressed.
Pumpdown	Initiates a pumpdown sequence.

Table 8 MS Parameters menu

Action	Description
High Vacuum Pressure	Only with Micro-Ion vacuum gauge installed.
Turbo Pump Speed	Displays the turbo pump speed.
Foreline Pressure	Displays the foreline pressure.
MSD Fault Status	Reports a summary fault status code (number) in 'dec' (decimal) and 'hex' (hexadecimal) format covering all possible fault combinations.
Ion Source Temp, °C	Displays and sets the ion source temperature.
Mass Filter Temp, °C	Displays and sets the mass filter temperature.
CI Reagent	Displays CI reagent gas and flow rate (if installed).

NOTE

MS parameters cannot be set from the LCP while an online GC/MSD ChemStation session is connected to the MSD.

Table 9 Network menu

Action	Description
MSD IP via BootP	Displays the IP address for the MSD.
Gateway IP Address	Displays the gateway IP address for the MSD.
Subnet Mask	Displays the subnet mask for the MSD.
ChemStation IP	Displays the IP address for the GC/MSD ChemStation.
GC IP Address	Displays the IP address for the GC.
Ping gateway	Checks communication with the gateway.

Table 9 Network menu (continued)

Action	Description
Ping ChemStation	Checks communication with the GC/MSD ChemStation.
Ping GC	Checks communication with the GC.
MS Controller MAC	Displays the MAC address of the SmartCard in the MSD.

Table 10 Version menu

Action	Description
Control firmware	Displays the MSD firmware version.
Operating system	Displays the GC/MSD ChemStation operating system version.
Front panel	Displays the version of the LCP.
Log amplifier	Displays version information.
Sideboard	Displays the sideboard type.
Mainboard	Displays the mainboard type.
Serial number	Is assigned to the MSD by GC/MSD ChemStation Configuration dialogue.

Table 11 Controller menu

Action	Description
Reboot controller	Starts the LAN/MS control card.
Test LCP?	Initiates a diagnostic test of the two-line display.
Test HTTP link to GC/MSD ChemStation?	Checks the status of the HTTP server.

The EI GC/MSD Interface

The GC/MSD interface ([Figure 12](#)) is a heated conduit into the MSD for the capillary column. It is bolted onto the right side of the analyzer chamber, with an O-ring seal. It has a protective cover which should be left in place.

One end of the GC/MSD interface passes through the side of the gas chromatograph and extends into the GC oven. This end is threaded to allow connection of the column with a nut and ferrule. The other end of the interface fits into the ion source. The last 1 to 2 millimeters of the capillary column extend past the end of the guide tube and into the ionization chamber.

The GC/MSD interface is heated by an electric cartridge heater. Normally, the heater is powered and controlled by Thermal Aux #2 heated zone of the GC. For 6850 Series GCs, the heater is connected to the auxiliary thermal zone. For the 7820A Series GC's, the heater is either connected to the rear inlet thermal zone for single inlet models or connected to the manual valve thermal zone for dual inlet models. The interface temperature can be set from the MSD ChemStation or from the gas chromatograph. A sensor (thermocouple) in the interface monitors the temperature.

The GC/MSD interface should be operated in the 250 ° to 350 °C range. Subject to that restriction, the interface temperature should be slightly higher than the maximum GC oven temperature, but never higher than the maximum column temperature.

The EI GC/MSD interface can only be used with the EI ion source. However, the CI GC/MSD interface can be used with either source.

See Also

[“To install a capillary column in the GC/MSD interface”](#) .

WARNING

The GC/MSD interface operates at high temperatures. If you touch it when it is hot, it will burn you.

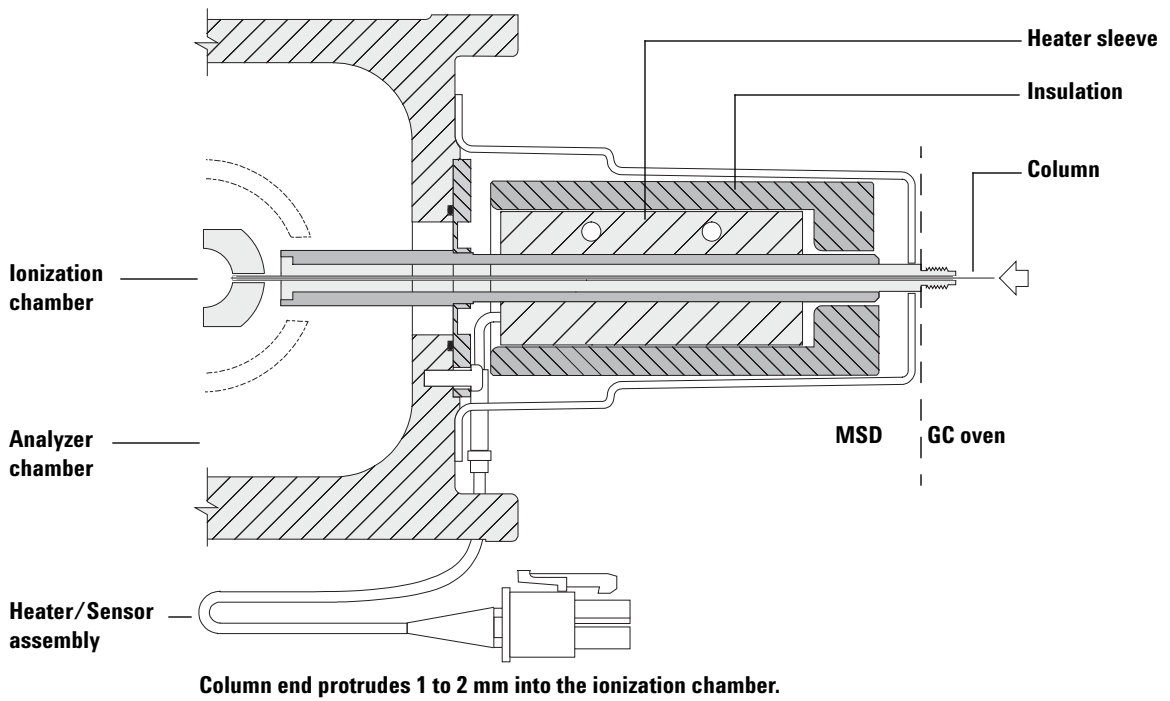

Figure 12 The EI GC/MSD interface

Before You Turn On the MSD



Verify the following before you turn on or attempt to operate the MSD.

- The vent valve must be closed (the knob turned all the way clockwise).
- All other vacuum seals and fittings must be in place and fastened correctly. (The the front side plate screw should not be tightened, unless hazardous carrier or reagent gasses are being used.
- The MSD is connected to a grounded power source.
- The GC/MSD interface extends into the GC oven.
- A conditioned capillary column is installed in the GC inlet and in the GC/MSD interface.
- The GC is on, but the heated zones for the GC/MSD interface, the GC inlet, and the oven are off.
- Carrier gas of at least 99.9995% purity is plumbed to the GC with the recommended traps.
- If hydrogen is used as carrier gas, carrier gas flow must be off and the front sideplate thumbscrew must be loosely fastened.
- The foreline pump exhaust is properly vented.

WARNING

The exhaust from the foreline pump contains solvents and the chemicals you are analyzing. If using the standard foreline pump, it also contains traces of pump oil. If you are using toxic solvents or analyzing toxic chemicals, remove the oil trap (standard pump) and install a hose (11-mm id) to take the foreline pump exhaust outside or to a fume (exhaust) hood. Be sure to comply with local regulations. The oil trap supplied with the standard pump stops only pump oil. It does not trap or filter out toxic chemicals.

WARNING

If you are using hydrogen as a carrier gas, do not start carrier gas flow until the MSD has been pumped down. If the vacuum pumps are off, hydrogen will accumulate in the MSD and an explosion may occur. Read [“Hydrogen Safety”](#) before operating the MSD with hydrogen carrier gas.

Pumping Down

The data system or local control panel helps you pump down the MSD. The process is mostly automated. Once you close the vent valve and turn on the main power switch (while pressing on the sideplate), the MSD pumps down by itself. The data system software monitors and displays system status during pumpdown. When the pressure is low enough, the program turns on the ion source and mass filter heaters and prompts you to turn on the GC/MSD interface heater. The MSD will shut down if it cannot pump down correctly.

Using the menus or MS monitors, the data system can display:

- Motor speed for turbo pump MSDs (percent spin speed)
- Foreline pressure for diffusion pump MSDs
- Analyzer chamber pressure (vacuum) for MSDs with the optional G3397A Micro-Ion Gauge Controller

The LCP can also display these data.

Controlling Temperatures

MSD temperatures are controlled through the data system. The MSD has independent heaters and temperature sensors for the ion source and quadrupole mass filter. You can adjust the setpoints and view these temperatures from the data system or from the local control panel.

Normally, the GC/MSD interface heater is powered and controlled by the Thermal Aux #2 heated zone of the GC. For the 6850 Series GCs, the heater is connected to the auxiliary thermal zone. For the 7820 Series GCs, the heater is either connected to the rear inlet thermal zone for single inlet models or is connected to the manual valve thermal zone for dual inlet models. The GC/MSD interface temperature can be set and monitored from the data system or from the GC.

Controlling Column Flow

Carrier gas flow is controlled by head pressure in the GC. For a given head pressure, column flow will decrease as the GC oven temperature increases. With electronic pneumatic control (EPC) and the column mode set to **Constant Flow**, the same column flow is maintained regardless of temperature.

The MSD can be used to measure actual column flow. You inject a small amount of air or other unretained chemical and time how long it takes to reach the MSD. With this time measurement, you can calculate the column flow. See [page 73](#).

Venting the MSD

A program in the data system guides you through the venting process. It turns off the GC and MSD heaters and diffusion pump heater or the turbo pump at the correct time. It also lets you monitor temperatures in the MSD and indicates when to vent the MSD.

The MSD will be damaged by incorrect venting. A diffusion pump will backstream vaporized pump fluid onto the analyzer if the MSD is vented before the diffusion pump has fully cooled. A turbo pump will be damaged if it is vented while spinning at more than 50% of its normal operating speed.

WARNING

Make sure the GC/MSD interface and the analyzer zones are cool (below 100 °C) before you vent the MSD. A temperature of 100 °C is hot enough to burn skin; always wear cloth gloves when handling analyzer parts.

WARNING

If you are using hydrogen as a carrier gas, the carrier gas flow must be off before turning off the MSD power. If the foreline pump is off, hydrogen will accumulate in the MSD and an explosion may occur. Read “[Hydrogen Safety](#)” before operating the MSD with hydrogen carrier gas.

CAUTION

Never vent the MSD by allowing air in through either end of the foreline hose. Use the vent valve or remove the column nut and column.

Do not vent while the turbo pump is still spinning at more than 50%.

Do not exceed the maximum recommended total gas flow. See “[5975 series MSD models and features](#)” .

To view MSD analyzer temperature and vacuum status

You can also use the Local Control Panel to perform this task. See the G1701EA GC/MSD *ChemStation Getting Started* manual for more information.

Procedure

- 1 In Instrument Control view, select **Edit Tune Parameters** from the Instrument menu (Figure 13).

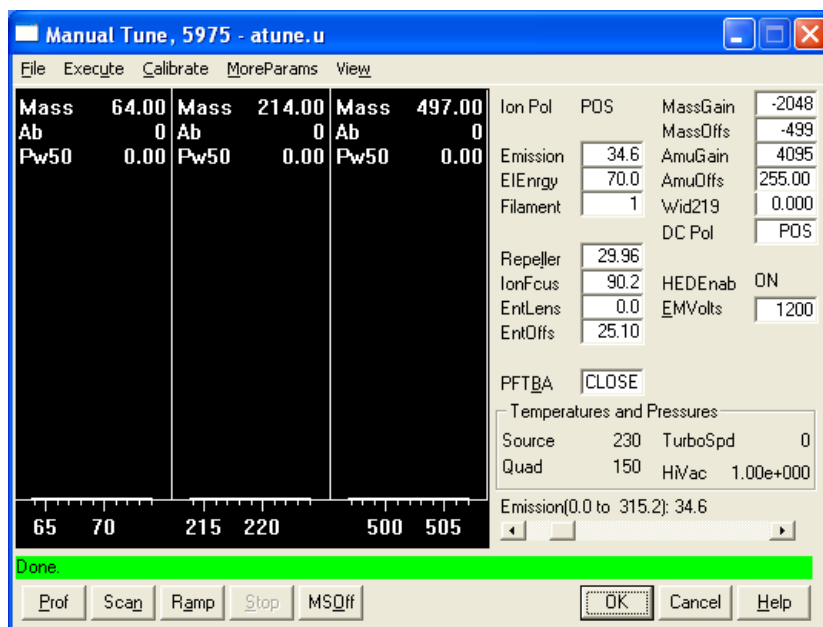

Figure 13 Tune parameters

- 2 Select the tune file you plan to use with your method from the **Load MS Tune File** dialog box.
- 3 Analyzer temperatures and vacuum status are displayed in the **Zones** field.

Unless you have just begun the pumpdown process, the foreline pressure should be less than 300 mTorr, or the turbo pump should be running at least 80% speed. MSD heaters remain off as long as the diffusion pump is cold or the turbo pump is operating at less than 80%. Normally, the foreline pressure will be below 100 mTorr, or the turbo pump speed will be at 100%.

The MSD heaters turn on at the end of the pumpdown cycle and turn off at the beginning of the vent cycle. The reported setpoints will not change during venting or pumpdown, even though both the MSD zones are turned off.

To set monitors for MSD temperature and vacuum status

A monitor displays the current value of a single instrument parameter. They can be added to the standard instrument control window. Monitors can be set to change color if the actual parameter varies beyond a user-determined limit from its setpoint.

Procedure

- 1 Select **MS Monitors** from the Instrument menu.
- 2 In the **Edit MS Monitors** box, under **Type**, select **Zone**.
- 3 Under **Parameter**, select **MS Source** and click **Add**.
- 4 Under **Parameter**, select **MS Quad** and click **Add**.
- 5 Under **Parameter**, select **Foreline** (or **TurboSpd**) and click **Add**.
- 6 Select any other monitors you want and **Add** them.
- 7 Click **OK**. The new monitors will be stacked on top of each other in the lower right corner of the Instrument Control window. They must be moved for you to see them all.
- 8 Click and drag each monitor to the desired position. See [Figure 14](#) for one way of arranging the monitors.

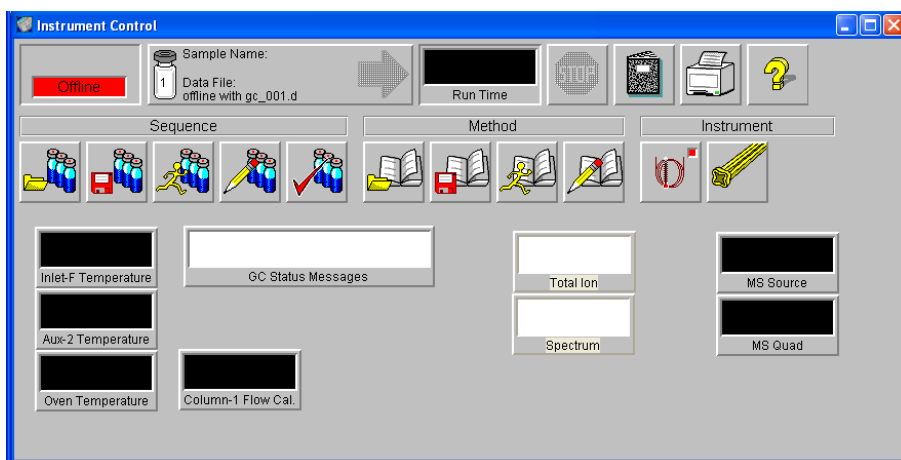

Figure 14 Arranging monitors

- 9 To make the new settings part of the method, select **Save** from the Method menu.

To set the MSD analyzer temperatures

Setpoints for the MSD ion source and mass filter (quad) temperatures are stored in the current tune (*.u) file. When a method is loaded, the setpoints in the tune file associated with that method are downloaded automatically.

Procedure

- 1 In Instrument Control view, select **Edit Tune Parameters** from the Instrument menu.
- 2 Select **Temperatures** from the **MoreParams** menu (Figure 15).

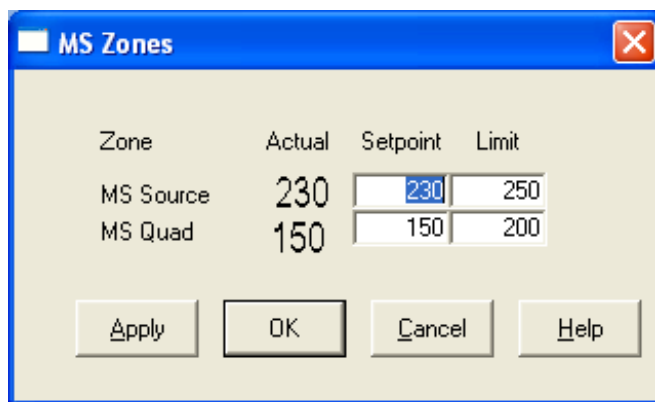

Figure 15 Setting temperatures

- 3 Type the desired Source and Quad (mass filter) temperatures in the setpoint fields. See [Table 12](#) for recommended setpoints.

The GC/MSD interface, ion source, and quadrupole heated zones interact. The analyzer heaters may not be able to accurately control temperatures if the setpoint for one zone is much different from that of an adjacent zone.

WARNING

Do not exceed 200 °C for the quadrupole or 350 °C for the source.

3 Operating in Electron Impact (EI) Mode

- 4 To close the screen, click:
 - **Apply** to send the new temperature setpoints to the MSD.
 - **OK** to change the currently loaded tune file but not download anything to the MSD (use **Apply**).
 - **Cancel** to exit the panel without changing the currently loaded tune file or downloading anything to the MSD.
- 5 When the **Save MS Tune File** dialog box appears, either click **OK** to save your changes to the same file or type a new file name and click **OK**.

Table 12 Recommended temperature settings

	EI operation	PCI operation	NCI operation
MS Source	230	250	150
MS Quad	150	150	150

To set the GC/MSD interface temperature from the ChemStation

You can also use the Local Control Panel to perform this task. See “Operating the MSD from the LCP” .

Procedure

- 1 Select **View>Instrument Control**.
- 2 Select **Instrument>GC Edit Parameters**.
- 3 Click the **Aux** icon to edit the interface temperature (Figure 16).

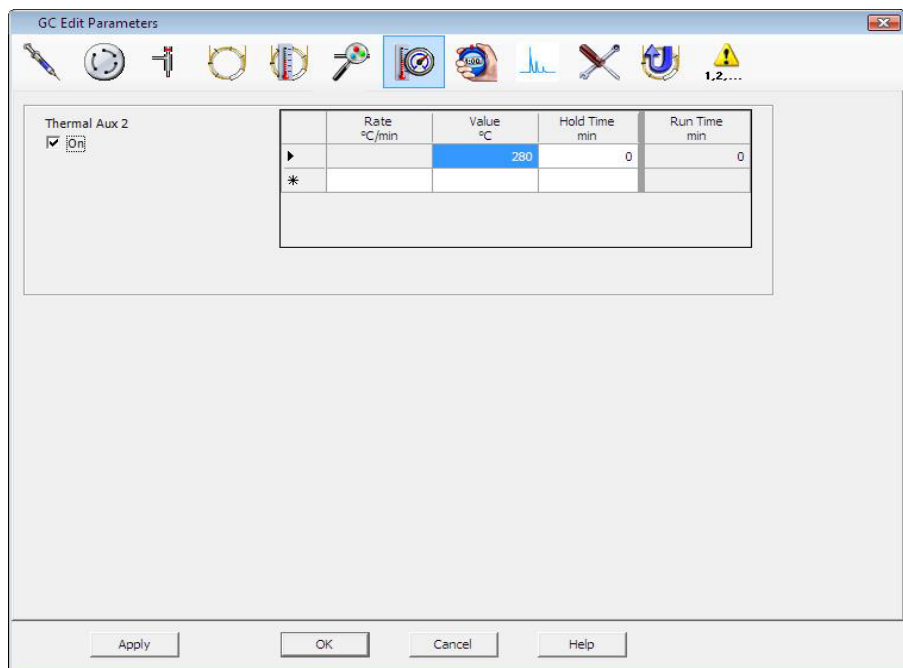

Figure 16 Setting the interface temperature

- 4 Check the heater **On** and type the setpoint in the **Value °C** column.

The typical setpoint is 280 °C. The limits are 0 °C and 350 °C. A setpoint below ambient temperature turns off the interface heater.

3 Operating in Electron Impact (EI) Mode

CAUTION

Never exceed the maximum temperature for your column.

- 5 Click **Apply** to download setpoints or click **OK** to download setpoints and close the window.
- 6 To make the new settings part of the method, select **Save** from the Method menu.

CAUTION

Make sure that the carrier gas is turned on and the column has been purged of air before heating the GC/MSD interface or the GC oven.

To monitor high vacuum pressure

Pressure monitoring requires an optional G3397A Micro-Ion vacuum gauge.

Materials needed

- Micro-Ion vacuum gauge (G3397A)

WARNING

If you are using hydrogen as a carrier gas, do not turn on the Micro-Ion vacuum gauge if there is any possibility that hydrogen has accumulated in the analyzer chamber. Read “[Hydrogen Safety](#)” before operating the MSD with hydrogen carrier gas.

Procedure

- 1 Start up and pump down the MSD ([page 91](#)).
- 2 In the Tune and Vacuum Control view select **Turn Vacuum Gauge on/off** from the Vacuum menu.
- 3 In the Instrument Control view you can set up an MS Monitor for reading. The vacuum can also be read on the LCP or from the Manual Tune screen.

The largest influence on operating pressure in EI mode is the carrier gas (column) flow. [Table 13](#) lists typical pressures for various helium carrier gas flows. These pressures are approximate and will vary from instrument to instrument by as much as 30%.

3 Operating in Electron Impact (EI) Mode

Table 13 Micro-Ion Vacuum Gauge Reading

Column flow rate, mL/min	Gauge reading, Torr <i>Performance turbo pump</i>	Gauge reading, Torr <i>Standard turbo pump</i>	Gauge reading, Torr <i>Diffusion pump</i>	Foreline reading, Torr <i>Diffusion pump</i>
0.5	3.18E-06	1.3E-05	2.18E-05	34.7
0.7	4.42E-06	1.83E-05	2.59E-05	39.4
1	6.26E-06	2.61E-05	3.66E-05	52.86
1.2	7.33E-06	3.11E-05	4.46E-05	60.866
2	1.24E-05	5.25E-05	7.33E-05	91.784
3	1.86E-05	8.01E-05	1.13E-04	125.76
4	2.48E-05			
6	3.75E-05			

If the pressure is consistently higher than those listed, refer to the online help in the MSD ChemStation software for information on troubleshooting air leaks and other vacuum problems.

To measure column flow linear velocity

With capillary columns, such as those used with the MSD, linear velocity is often measured rather than volumetric flow rate.

Procedure

- 1 Set Data Acquisition for splitless manual injection and selected ion monitoring (SIM) of m/z 28.
- 2 Press **Prep Run** on the GC keypad.
- 3 Inject 1 μ L of air into the GC inlet and press **Start Run**.
- 4 Wait until a peak elutes at m/z 28. Note the retention time.
- 5 Calculate the average linear velocity.

$$\text{Average linear velocity (cm/s)} = \frac{100 L}{t}$$

where:

L = Length of the column in meters

t = Retention time in seconds

Be sure to account for any pieces of column broken off. A 1-meter section missing from a 25-meter column can yield a 4% error.

- 6 Use this velocity to verify the MSD ChemStation flow calculations (page 74).
If the numbers disagree, click **Change** to calibrate the column dimensions.
- 7 To calculate the volumetric flow rate.

$$\text{Volumetric flow rate (mL/min)} = \frac{0.785 D^2 L}{t}$$

where:

D = Internal column diameter in millimeters

L = Column length in meters

t = Retention time in minutes

To confirm column flow

Volumetric flow can be calculated from the column head pressure if the column dimensions are known.

Procedure

- 1 In the Instrument Control view, select **Instrument>GC Edit Parameters**.
- 2 Click the **Columns** icon (Figure 17 shows an example).
- 3 Select the appropriate column. .

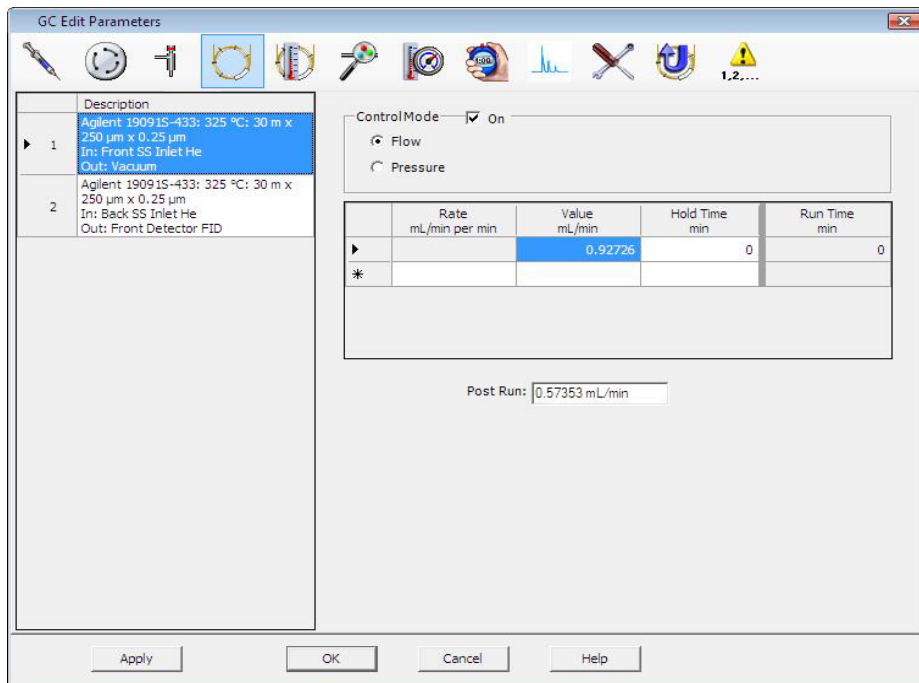

Figure 17 Calculating column flow

To tune the MSD

You can also use the Local Control Panel to run the autotune that is currently loaded in the PC memory. See “Operating the MSD from the LCP” .

Procedure

- 1 In the Instrument Control View, verify the correct tune file is loaded. For most applications, ATUNE.U (**Autotune**) gives good results. STUNE.U (**Standard Tune**) is not recommended as it may reduce sensitivity.

Consider Gain autotune (GAIN.U + HiSense.U). This tunes to a target gain rather than a target abundance. It offers excellent reproducibility, both of run-to-run abundance but also between different instruments,
- 2 Set the system to the same conditions (GC oven temperature and column flow, and MSD analyzer temperatures) that will be used for data acquisition.
- 3 Select **Tune MSD** to perform a complete tune, or select **Quick Tune** to adjust peak width, mass assignment, and abundance, without changing ion ratios. If your system is configured for CI, you will be able to access the CI Tune panel from this box. The tune will start immediately.
- 4 Wait for the tune to complete and to generate the report.

Save your tune reports. To view history of tune results, select **Checkout>View Previous Tunes....**

To manually tune your MSD or to perform special autotunes, go to the Tune and Vacuum Control View.

From this Tune menu, in addition to the tunes available from Instrument Control, you can select special autotunes for specific spectral results, such as **DFTPP Tune** or **BFB Tune**.

See the manuals or online help provided with your MSD ChemStation software for additional information about tuning.

To verify system performance

Materials needed

- 1 pg/ μ L (0.001 ppm) OFN sample (5188-5348)

Verify the tune performance

- 1 Verify that the system has been pumping down for at least 60 minutes.
- 2 Set the GC oven temperature to 150 °C and the column flow to 1.0 mL/min.
- 3 In the Instrument Control view, select **Checkout Tune** from the Checkout menu. The software will perform an autotune and print the report.
- 4 When the autotune has completed, save the method and then select **Evaluate Tune** from the Checkout menu.

The software will evaluate the last autotune and print a System Verification – Tune report.

Verify the sensitivity performance

- 1 Set up to inject 1 μ L of OFN, either with the ALS or manually.
- 2 In the Instrument Control view, select **Sensitivity Check** from the Checkout menu.
- 3 Click the appropriate icons in the Instrument | Edit window to edit the method for the type of injection.
- 4 Click **OK** to run the method.

When the method is completed, an evaluation report will be printed.

Verify that rms signal-to-noise ratio meets the published specification. Please see the Agilent Web site at www.agilent.com/chem for specifications.

High-Mass Testing (5975 Series MSDs)

Setup conditions

- 1 Obtain a sample of PFHT (5188-5357).
- 2 Load tune file ATUNE.U then auto tune the MSD.
- 3 Resolve the PFHT.M method under x\5975\PFHT.M where x is instrument number being used.
- 4 Update and save the method.

High-mass checkout

- 1 Load sample into a vial and place in position 2.
- 2 Select **High Mass Check** from the **Checkout** menu.
- 3 Follow the instructions on screen.
- 4 The Run is completed and results are printed within 5 minutes.

3 Operating in Electron Impact (EI) Mode

Results

*PFHT HIGH MASS REPORT

Data File : C:\msdchem\1\5975\HighMass3.d Vial: 2
Acq On : 28 Apr 2005 15:07 Operator:
Sample : *HIGH MASS TEST Inst : Instrument #1
Misc : _[] Multiplr: 1.00
Barcode : *EXPECTED=* <NONE> ACTUAL=* <NONE> Sample Amount:0.00
MS Integration Params: NA

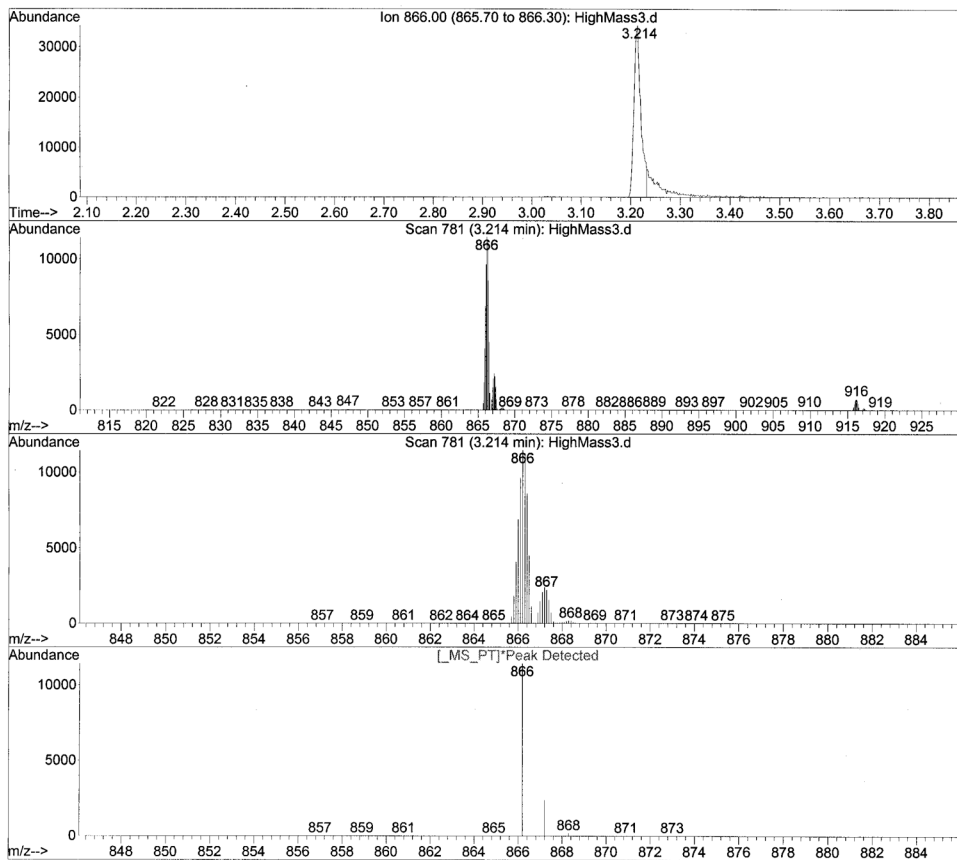

* MASS	ACTUAL	ISOTOPE	ABUND	ISOTOPE	RATIO	RELATIVE	WIDTH
866.00	866.20	867.20	11439	2402	21.00	100.00	0.512
867.00	867.20	868.30	2402	171	7.12	21.00	0.512
916.00	916.20	917.20	742	155	20.89	6.49	0.553

Figure 18 PFHT high mass report

Results will indicate the recommended amount to adjust AMU offset for high-mass. If your results are within 5 units of the targeted amount, there is no need to make adjustments.

Adjustments

- 1 Verify ATUNE.U has been loaded.
- 2 Select **Edit Tune Parameters** from the Instrument menu via Instrument Control.
- 3 Click on **MoreParams** and select **DynamicRamping Params...**
 - a Select AMU offset from the drop down box.
 - b If the values on the right side are greyed out then select the **Enable Dynamic Ramping For This Lens** checkbox.
 - c Enter in the recommend offset and click **OK**.
- 4 Click **OK** on the Edit Parameters box. The Save MS Tune File dialog box appears.

You can overwrite the existing ATUNE.U to include high-mass adjustment or save this file to a new name, for example, ATUNEHIGH.U.

NOTE

Anytime an ATUNE.U is performed it will overwrite the AMU offset which was entered. This is the reason for renaming the tune.

-
- 5 Load the PFHT.M and the saved tune file, then save the method.
 - 6 Rerun test mixture (repeat high-mass checkout). If the correction is within 5 units, no further adjustments are required.

To remove the MSD covers

Materials needed

- Screwdriver, Torx T-15 (8710-1622)

If you need to remove one of the MSD covers, follow these procedures (Figure 19):

To remove the analyzer top cover



Remove the five screws and lift the cover off.

To remove the analyzer window cover



- 1 Press down on the rounded area on the top of the window.
- 2 Lift the window forward and off the MSD.

WARNING

Do not remove any other covers. Dangerous voltages are present under other covers.

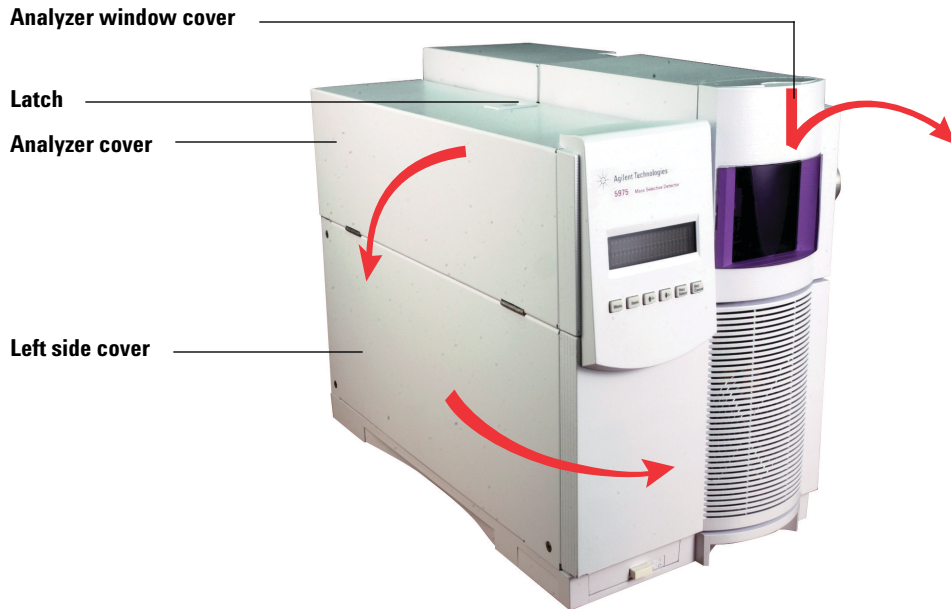

Figure 19 Removing covers

CAUTION

Do not use excessive force or the plastic tabs that hold the cover to the mainframe will break off.

To vent the MSD

Procedure

- 1 Select **Vent** from the Vacuum menu in the software. Follow the instructions presented.
- 2 Set the GC/MSD interface heater and the GC oven temperatures to ambient (room temperature).

WARNING

If you are using hydrogen as a carrier gas, the carrier gas flow must be off before turning off the MSD power. If the foreline pump is off, hydrogen will accumulate in the MSD and an explosion may occur. Read **“Hydrogen Safety”** before operating the MSD with hydrogen carrier gas.

CAUTION

Be sure the GC oven and the GC/MSD interface are cool before turning off carrier gas flow.

- 3 When prompted, turn off the MSD power switch.
- 4 Unplug the MSD power cord.

WARNING

When the MSD is vented, do not put the ChemStation into Instrument Control view. Doing so will turn on the interface heater.

5 Remove the analyzer window cover (page 80)

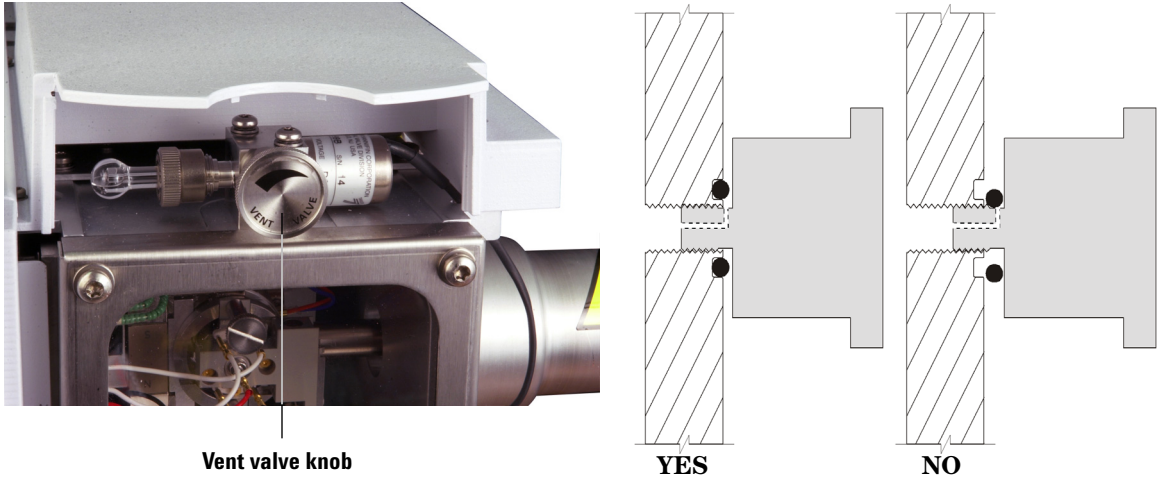

Figure 20 Venting the MSD



6 Turn the vent valve knob (Figure 20) counterclockwise *only* 3/4 turns or until you hear the hissing sound of air flowing into the analyzer chamber.

Do not turn the knob too far or the O-ring may fall out of its groove. Be sure to retighten the knob before pumping down.

WARNING

Allow the analyzer to cool to near room temperature before touching it.

CAUTION

Always wear clean gloves while handling any parts that go inside the analyzer chamber.

WARNING

When the MSD is vented, do not put the ChemStation into Instrument Control view. Doing so will turn on the interface heater.

To open the analyzer chamber

Materials needed

- Gloves, clean, lint-free
 - Large (8650-0030)
 - Small (8650-0029)
- Wrist strap, antistatic
 - Small (9300-0969)
 - Medium (9300-1257)
 - Large (9300-0970)

CAUTION

Electrostatic discharges to analyzer components are conducted to the side board where they can damage sensitive components. Wear a grounded antistatic wrist strap and take other antistatic precautions (see [page 131](#)) before you open the analyzer chamber.

Procedure



- 1 Vent the MSD ([page 82](#)).
- 2 Disconnect the side board control cable and the source power cable from the side board.
- 3 Loosen the side plate thumbscrews ([Figure 21](#)) if they are fastened.

The rear side plate thumbscrew should be unfastened during normal use. It is only fastened during shipping. The front side plate thumbscrew should only be fastened for CI operation or if hydrogen or other flammable or toxic substances are used for carrier gas.

CAUTION

In the next step, if you feel resistance, **stop**. Do not try to force the side plate open. Verify that MSD is vented. Verify that both the front and rear side plate screws are completely loose.

- 4 *Gently* swing the side plate out.

WARNING

The analyzer, GC/MSD interface, and other components in the analyzer chamber operate at very high temperatures. Do not touch any part until you are sure it is cool.

CAUTION

Always wear clean gloves to prevent contamination when working in the analyzer chamber.

3 Operating in Electron Impact (EI) Mode

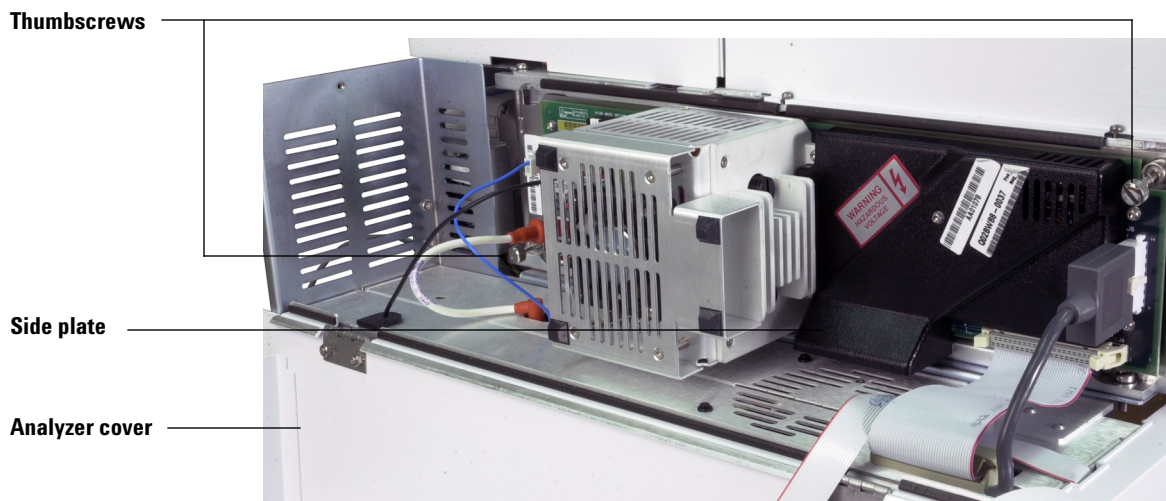

CHAMBER CLOSED

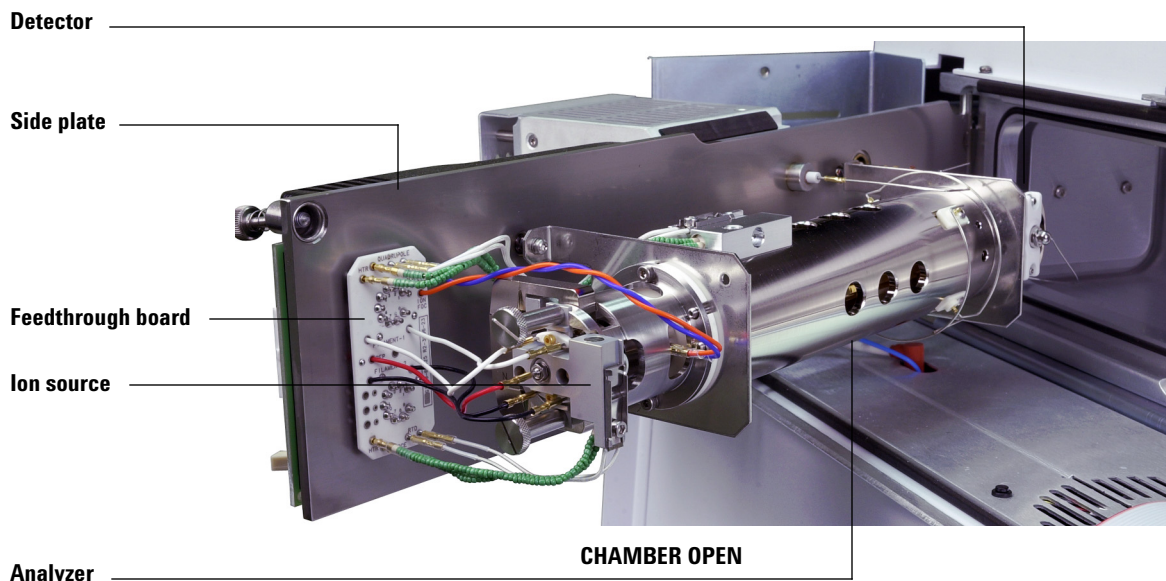

CHAMBER OPEN

Figure 21 The analyzer chamber

To close the analyzer chamber

Materials needed

- Gloves, clean, lint-free
 - Large (8650-0030)
 - Small (8650-0029)

Procedure

- 1 Make sure all the internal analyzer electrical leads are correctly attached. Wiring is the same for both the EI and CI sources.

The wiring is described in [Table 14](#) and illustrated in [Figure 22](#) and [Figure 23](#). The term “Board” in the table refers to the feedthrough board located next to the ion source.

Table 14 Analyzer wiring

Wire description	Attached to	Connects to
Green beaded (2)	Quad heater	Board, top left (HTR)
White with braided cover (2)	Quad sensor	Board, top (RTD)
White (2)	Board, center (FILAMENT-1)	Filament 1 (top)
Red (1)	Board, center left (REP)	Repeller
Black (2)	Board, center (FILAMENT-2)	Filament 2 (bottom)
Orange (1)	Board, top right (ION FOC)	Ion focus lens
Blue (1)	Board, top right (ENT LENS)	Entrance lens
Green beaded (2)	Ion source heater	Board, bottom left (HTR)
White (2)	Ion source sensor	Board, bottom (RTD)

3 Operating in Electron Impact (EI) Mode

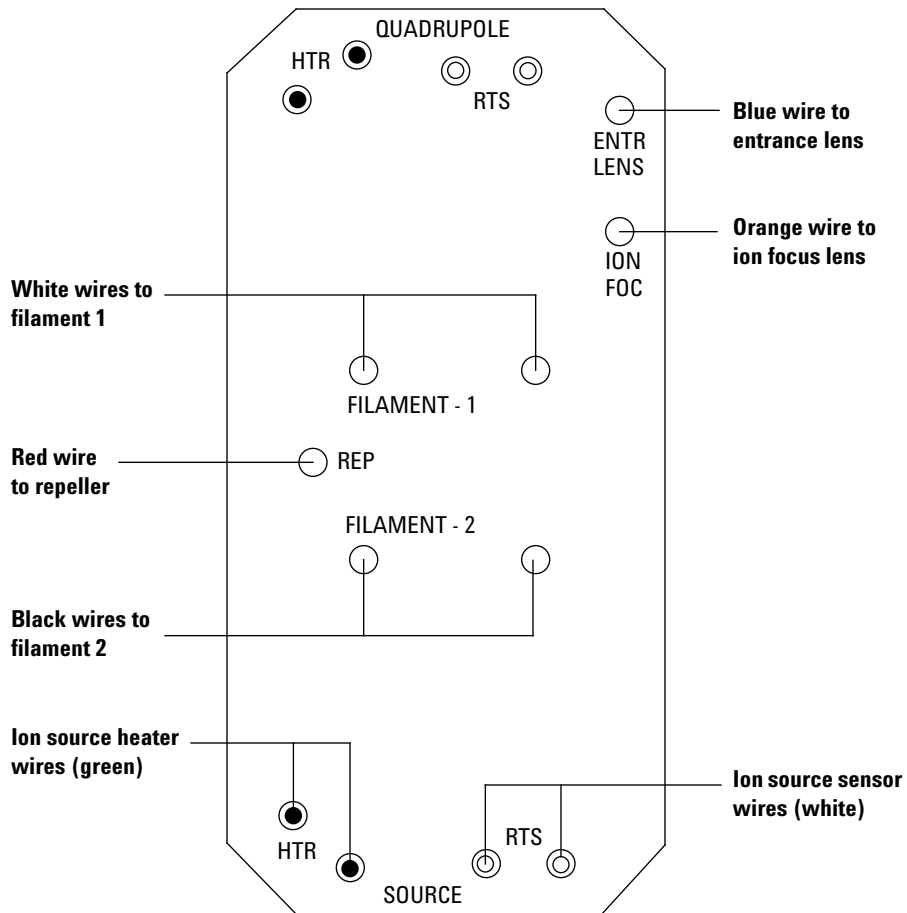

Figure 22 Feedthrough board wiring

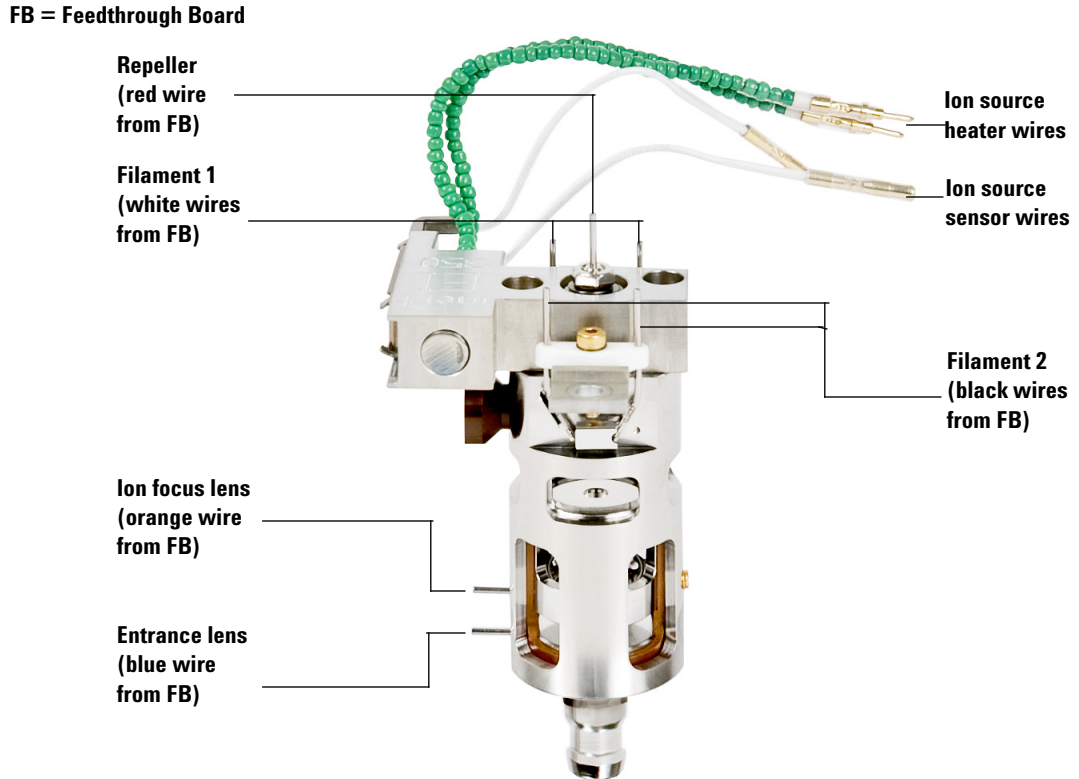

Figure 23 Ion source wiring

2 Check the side plate O-ring.

Make sure the O-ring has a very light coat of Apiezon L high vacuum grease. If the O-ring is very dry, it may not seal well. If the O-ring looks shiny, it has too much grease on it. (Refer to the 5975 Series MSD Troubleshooting and Maintenance Manual for lubricating instructions.)

3 Operating in Electron Impact (EI) Mode

- 3 Close the side plate.
- 4 Reconnect the side board control cable and source power cable to the side board.
- 5 Make sure the vent valve is closed.
- 6 Pump down the MSD ([page 91](#)).
- 7 If you are operating in CI mode or if hydrogen or other flammable or toxic substance is used for carrier gas, *gently* hand tighten the front side plate thumbscrew.

WARNING

The front thumbscrew must be fastened for CI operation or if hydrogen (or other hazardous gas) is being used as the GC carrier gas. In the unlikely event of an explosion, it may prevent the side plate from opening.

CAUTION

Do not overtighten the thumbscrew; it can cause air leaks or prevent successful pumpdown. Do not use a screwdriver to tighten the thumbscrew.

- 8 Once the MSD has pumped down, close the analyzer cover.

To pump down the MSD

You can also use the Local Control Panel to perform this task. See “[Operating the MSD from the LCP](#)” .

WARNING

Make sure your MSD meets all the conditions listed in the introduction to this chapter (page 60) before starting up and pumping down the MSD. Failure to do so can result in personal injury.

WARNING

If you are using hydrogen as a carrier gas, do not start carrier gas flow until the MSD has been pumped down. If the vacuum pumps are off, hydrogen will accumulate in the MSD and an explosion may occur. Read “[Hydrogen Safety](#)” before operating the MSD with hydrogen carrier gas.



Procedure

- 1 Close the vent valve.
- 2 Plug in the MSD power cord.
- 3 Open the MSD Analyzer top cover.
- 4 Turn on the MSD while engaging the side plate to the manifold using hand pressure.
- 5 Press lightly on the side board to ensure a correct seal. Press on the metal box on the side board.

The foreline pump will make a gurgling noise. This noise should stop within a minute. If the noise continues, there is a large air leak in your system, probably at the side plate seal, the interface column nut, or the vent valve.

- 6 Start the ChemStation and select **Tune and Vacuum Control** from the View menu.
- 7 Select **Pump Down** from the Vacuum menu.

3 Operating in Electron Impact (EI) Mode

- 8 Once communication with the PC has been established, click **OK**.

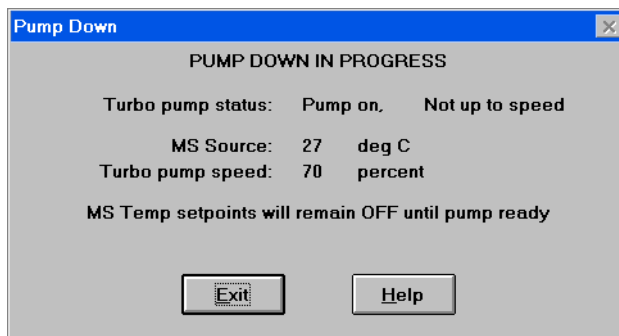

Figure 24 Pumping down

CAUTION

Within 10 to 15 minutes the diffusion pump should be hot, or the turbo pump speed should be up to 80% (Figure 24). The pump speed should eventually reach 95%. If these conditions are not met, the MSD electronics will shut off the foreline pump. In order to recover from this condition, you must power cycle the MSD. If the MSD does not pump down correctly, see the manual or online help for information on troubleshooting air leaks and other vacuum problems.

- 9 When prompted, turn on the GC/MSD interface heater and GC oven. Click **OK** when you have done so.

The software will turn on the ion source and mass filter (quad) heaters. The temperature setpoints are stored in the current autotune (*.u) file.

CAUTION

Do not turn on any GC heated zones until carrier gas flow is on. Heating a column with no carrier gas flow will damage the column.

- 10 After the message **Okay to run** appears, wait 2 hours for the MSD to reach thermal equilibrium. Data acquired before the MSD has reached thermal equilibrium may not be reproducible.

To move or store the MSD

Materials needed

- Ferrule, blank (5181-3308)
- Interface column nut (05988-20066)
- Wrench, open-end, 1/4-inch × 5/16-inch (8710-0510)

Procedure

- 1 Vent the MSD ([page 82](#)).
- 2 Remove the column and install a blank ferrule and interface nut.
- 3 Tighten the vent valve.
- 4 Move the MSD away from the GC (see the 5975 Series MSD Troubleshooting and Maintenance Manual).
- 5 Unplug the GC/MSD interface heater cable from the GC.
- 6 Install the interface nut with the blank ferrule.
- 7 Open the analyzer cover ([page 80](#)).
- 8 Finger-tighten the side plate thumbscrews ([Figure 25](#)).

CAUTION

Do not overtighten the side plate thumbscrews. Overtightening will strip the threads in the analyzer chamber. It will also warp the side plate and cause leaks.

- 9 Plug the MSD power cord in.
- 10 Switch the MSD on to establish a rough vacuum. Verify that the turbo pump speed is greater than 50% or that the foreline pressure is ~1 Torr.
- 11 Switch the MSD off.
- 12 Close the analyzer cover.
- 13 Disconnect the LAN, remote, and power cables.

3 Operating in Electron Impact (EI) Mode

Front thumbscrew

Rear thumbscrew



Figure 25 Side plate thumbscrews

The MSD can now be stored or moved. The foreline pump cannot be disconnected; it must be moved with the MSD. Make sure the MSD remains upright and is never tipped on its side or inverted.

CAUTION

The MSD must remain upright at all times. If you need to ship your MSD to another location, contact your Agilent Technologies service representative for advice about packing and shipping.

To set the interface temperature from the GC

If desired, the interface temperature can be set directly at the GC. For the Agilent 7890A and 6890, set the Aux #2 temperature. For the 6850, use the optional handheld controller to set the thermal aux temperature. Refer to the GC User documentation for details.

CAUTION

Never exceed the maximum temperature of your column.

CAUTION

Make sure that the carrier gas is turned on and the column has been purged of air before heating the GC/MSD interface or the GC oven.

If you want the new setpoint to become part of the current method, click **Save** under the Method menu. Otherwise, the first time a method is loaded, all the setpoints in the method will overwrite those set from the GC keyboard.

3 Operating in Electron Impact (EI) Mode



4 Operating in Chemical Ionization (CI) Mode

General Guidelines	98
The CI GC/MSD Interface	99
To Operate the CI MSD	101
To switch from the EI source to the CI source	102
To pump down the CI MSD	103
To set up the software for CI operation	104
To operate the reagent gas flow control module	106
To set up methane reagent gas flow	109
To use other reagent gases	111
To switch from the CI source to the EI source	115
CI Autotune	116
To perform a PCI autotune (methane only)	118
To perform an NCI autotune (methane reagent gas)	120
To verify PCI performance	122
To verify NCI performance	123
To monitor high vacuum pressure	124

This chapter provides information and instructions for operating the 5975 Series CI MSDs in Chemical Ionization (CI) mode. Most of the information in the preceding chapter is also relevant.

Most of the material is related to methane chemical ionization but one section discusses the use of other reagent gases.

The software contains instructions for setting the reagent gas flow and for performing CI autotunes. Autotunes are provided for positive CI (PCI) with methane reagent gas and for negative CI (NCI) with any reagent gas.



General Guidelines

- Always use the highest purity methane (and other reagent gases, if applicable.) Methane must be at least 99.9995% pure.
- Always verify the MSD is performing well in EI mode before switching to CI. See [“To verify system performance”](#) .
- Make sure the CI ion source and GC/MSD interface tip seal are installed.
- Make sure the reagent gas plumbing has no air leaks. This is determined in PCI mode, checking for m/z 32 after the methane pretune.

The CI GC/MSD Interface

The CI GC/MSD interface (Figure 26) is a heated conduit into the MSD for the capillary column. It is bolted onto the right side of the analyzer chamber, with an O-ring seal and has a protective cover which should be left in place.

One end of the interface passes through the side of the GC and extends into the oven. It is threaded to allow connection of the column with a nut and ferrule. The other end of the interface fits into the ion source. The last 1 to 2 millimeters of the capillary column extend past the end of the guide tube and into the ionization chamber.

Reagent gas is plumbed into the interface. The tip of the interface assembly extends into the ionization chamber. A spring-loaded seal keeps reagent gases from leaking out around the tip. The reagent gas enters the interface body and mixes with carrier gas and sample in the ion source.

The GC/MSD interface is heated by an electric cartridge heater. Normally, the heater is powered and controlled by Thermal Aux #2 heated zone of the GC. For 6850 Series GCs, the heater is connected to the auxiliary thermal zone. The interface temperature can be set from the MSD ChemStation or from the gas chromatograph. A sensor (thermocouple) in the interface monitors the temperature.

This interface is also used for EI operation in CI MSDs.

The interface should be operated in the 250 ° to 350 °C range. Subject to that restriction, the interface temperature should be slightly higher than the maximum GC oven temperature, but never higher than the maximum column temperature.

See Also

[“To install a capillary column in the GC/MSD interface”](#) .

CAUTION

Never exceed the maximum column temperature, either in the GC/MSD interface, the GC oven, or the inlet.

4 Operating in Chemical Ionization (CI) Mode

WARNING

The GC/MSD interface operates at high temperatures. If you touch it when it is hot, it will burn you.

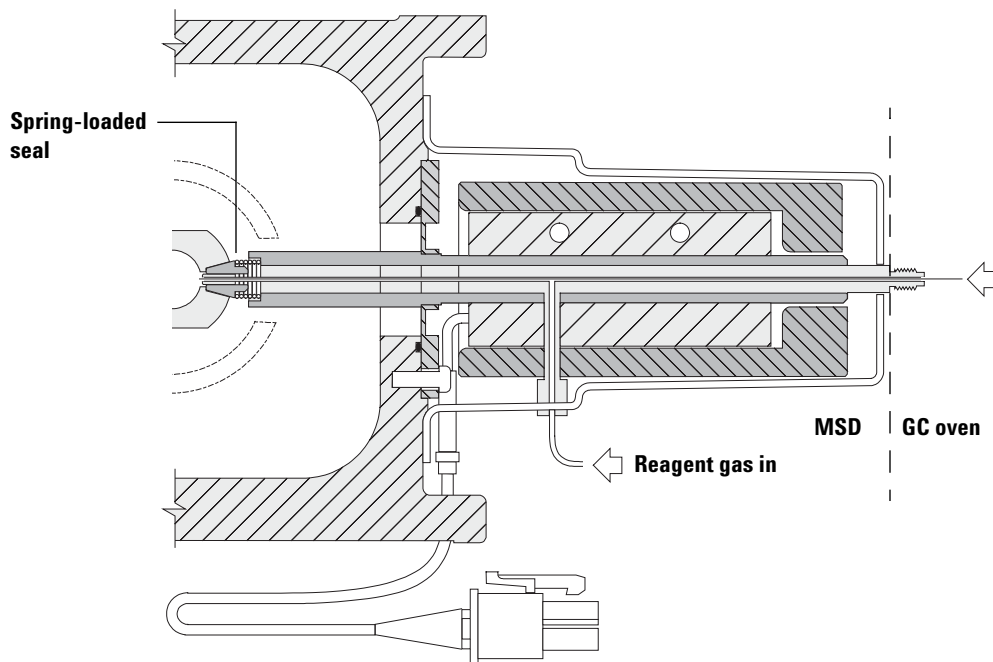

Column end protrudes 1 to 2 mm into the ionization chamber.

Figure 26 The CI GC/MSD interface

To Operate the CI MSD

Operating your MSD in the CI mode is slightly more complicated than operating in the EI mode. After tuning, gas flow, source temperature (Table 15), and electron energy may need to be optimized for your specific analyte.

Table 15 Temperatures for CI operation

	Ion source	Quadrupole	GC/MSD interface
PCI	250 °C	150 °C	280 °C
NCI	150 °C	150 °C	280 °C

Start the system in PCI mode

By bringing the system up in PCI mode first, you will be able to do the following:

- Set up the MSD with methane first, even if you are going to use another reagent gas.
- Check the interface tip seal by looking at the m/z 28 to 27 ratio (in the methane flow adjust panel).
- Tell if a gross air leak is present by monitoring the ions at m/z 19 (protonated water) and 32.
- Confirm that the MS is generating “real” ions and not just background noise.

It is nearly impossible to perform any diagnostics on the system in NCI. In NCI, there are no reagent gas ions to monitor. It is difficult to diagnose an air leak and difficult to tell whether a good seal is being created between the interface and the ion volume.

To switch from the EI source to the CI source

CAUTION

Always verify MSD performance in EI before switching to CI operation.
Always set up the CI MSD in PCI first, even if you are going to run NCI.

Procedure

- 1 Vent the MSD. See [page 82](#).
- 2 Open the analyzer.
- 3 Remove the EI ion source. See [page 134](#).

CAUTION

Electrostatic discharges to analyzer components are conducted to the side board where they can damage sensitive components. Wear a grounded antistatic wrist strap. See “[Electrostatic discharge](#)”. Take antistatic precautions **before** you open the analyzer chamber.

- 4 Install the CI ion source. See [page 142](#).
- 5 Install the interface tip seal. See [page 143](#).
- 6 Close the analyzer.
- 7 Pump down the MSD. See [page 103](#).

To pump down the CI MSD

You can also use the Local Control Panel to perform this task. See “[Operating the MSD from the LCP](#)” .

Procedure

- 1 Follow the instructions for the EI MSD. See “[To pump down the MSD](#)” .

After the software prompts you to turn on the interface heater and GC oven, perform the following steps.

- 2 Check the vacuum gauge, if present, to verify that the pressure is decreasing.
- 3 Press **Shutoff Valve** to close the gas supply and shutoff valves.
- 4 Verify that **PCICH4.U** is loaded and accept the temperature setpoints.

Always start up and verify system performance in PCI mode before switching to NCI.

- 5 Set the GC/MSD interface to 280 °C.
- 6 Set **Gas A** to 20%.
- 7 Let the system bake out and purge for at least 2 hours. If you will be running NCI, best sensitivity, bake out the MSD overnight.

To set up the software for CI operation

Procedure

- 1 Switch to the Tune and Vacuum Control view.
- 2 Select **Load Tune Values** from the File menu.
- 3 Select the tune file **PCICH4.U**.
- 4 If CI autotune has never been run for this tune file, the software will prompt you through a series of dialog boxes. *Accept the default values unless you have a very good reason for changing anything.*

The tune values have a dramatic effect on MSD performance. Always start with the default values when first setting up for CI, and then make adjustments for your specific application. See [Table 16](#) for default values for the Tune Control Limits box.

NOTE

These limits are used by Autotune only. They should *not* be confused with the parameters set in Edit MS Parameters or with those appearing on the tune report.

Table 16 Default Tune Control Limits, used by CI autotune only

Reagent gas	Methane		Isobutane		Ammonia	
	Positive	Negative	Positive	Negative	Positive	Negative
Ion polarity	Positive	Negative	Positive	Negative	Positive	Negative
Abundance target	1x10 ⁶	1x10 ⁶	N/A	1x10 ⁶	N/A	1x10 ⁶
Peakwidth target	0.6	0.6	N/A	0.6	N/A	0.6
Maximum repeller	4	4	N/A	4	N/A	4
Maximum emission current, μ A	240	50	N/A	50	N/A	50
Max electron energy, eV	240	240	N/A	240	N/A	240

Notes for Table 16:

- **N/A** Not available. There are no PFDTD ions formed in PCI with any reagent gas but methane, hence, CI autotune is not available with these configurations.
- **Ion polarity** Always set up in PCI with methane first, then switch to your desired ion polarity and reagent gas.
- **Abundance target** Adjust higher or lower to get desired signal abundance. Higher signal abundance also gives higher noise abundance. This is adjusted for data acquisition by setting the EMV in the method.
- **Peakwidth target** Higher peakwidth values give better sensitivity, lower values give better resolution.
- **Maximum emission current** Optimum emission current maximum for NCI is very compound-specific and must be selected empirically. Optimum emission current for pesticides, for example, may be about 200 μ A.

To operate the reagent gas flow control module

Reagent gas flows are controlled in software (Figure 27).

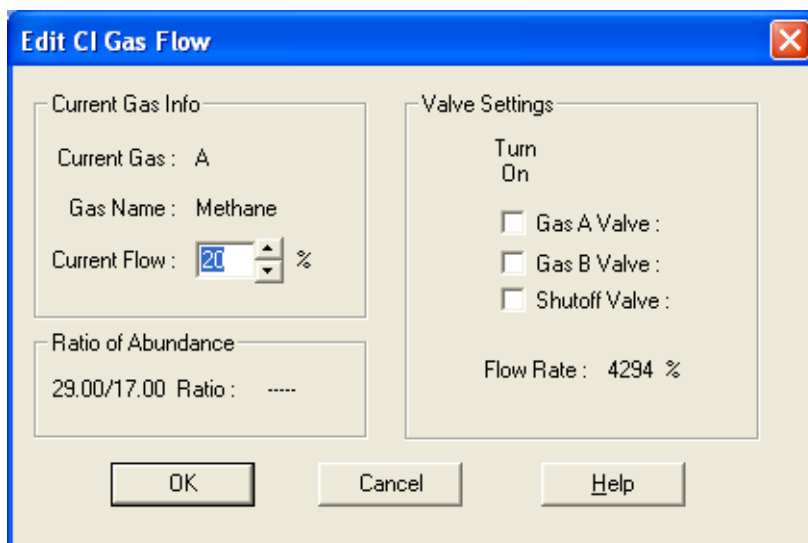

Figure 27 CI flow control

The Valve Settings have the following effects:

Gas A (or B) Valve The present gas flow, if any, is turned off. The system evacuates the gas lines for 6 minutes, then turns on the selected gas (A or B). This is to reduce cross-mixing of the gases in the lines.

Shutoff Valve When Shutoff Valve is selected, the system turns off the present gas flow while leaving the shutoff valve (Figure 28) open. This is to remove any residual gas in the lines. Typical evacuation time is 6 minutes and then the shutoff valve is closed.

The flow control hardware remembers the flow setting for each gas. When either gas is selected, the control board automatically sets the same flow that was used for that gas last time.

The flow control module

The CI reagent gas flow control module (Figure 28 and Table 17) regulates the flow of reagent gas into the CI GC/MSD interface. The flow module consists of a mass flow controller (MFC), gas select valves, CI calibration valve, shutoff valve, control electronics, and plumbing.

The back panel provides Swagelok inlet fittings for methane (**CH₄**) and one **OTHER** reagent gas. The software refers to them as **Gas A** and **Gas B**, respectively. If you are not using a second reagent gas, cap the **OTHER** fitting to prevent accidental admission of air to the analyzer. Supply reagent gases at 25 to 30 psi (170 to 205 kPa).

The shutoff valve prevents contamination of the flow control module by atmosphere while the MSD is vented or by PFTBA during EI operation. The MSD monitors will reflect **On** as **1** and **Off** as **0** (see Table 17).

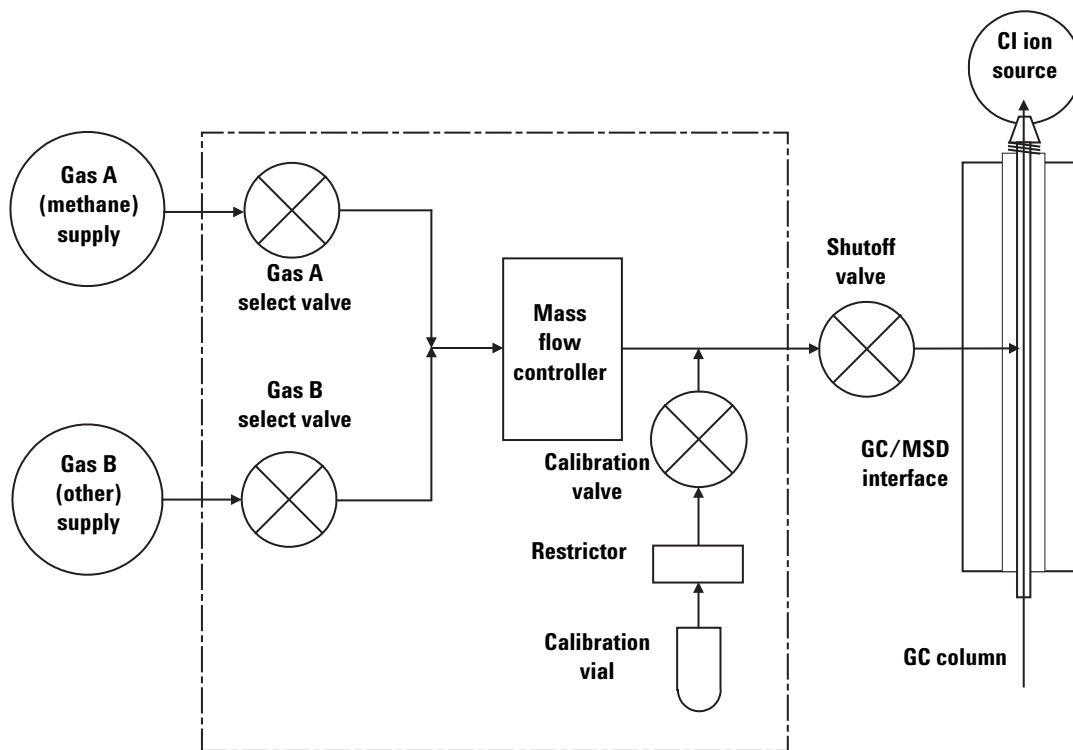

Figure 28 Reagent gas flow control module schematic

4 Operating in Chemical Ionization (CI) Mode

Table 17 Flow control module state diagram

Result	Gas A flow	Gas B flow	Purge with Gas A	Purge with Gas B	Pump out flow module	Standby, vented, or EI mode
Gas A	Open	Closed	Open	Closed	Closed	Closed
Gas B	Closed	Open	Closed	Open	Closed	Closed
MFC	On → setpoint	On → setpoint	On → 100%	On → 100%	On → 100%	Off → 0%
Shutoff valve	Open	Open	Open	Open	Open	Closed

The **Open** and **Closed** states are shown in the monitors as **1** and **0** respectively.

To set up methane reagent gas flow

The reagent gas flow must be adjusted for maximum stability before tuning the CI system. Do the initial setup with methane in positive chemical ionization (PCI) mode. No flow adjustment procedure is available for NCI, as no negative reagent ions are formed.

Adjusting the methane reagent gas flow is a three-step process: setting the flow control, pretuning on the reagent gas ions, and adjusting the flow for stable reagent ion ratios, for methane, m/z 28/27.

Your data system will prompt you through the flow adjustment procedure.

CAUTION

After the system has been switched from EI to CI mode, or vented for any other reason, the MSD must be baked out for at least 2 hours before tuning.

Procedure

- 1 Select **Gas A**. Follow the instructions and prompts from the Tune Wizard.
- 2 Set the flow to 20% for PCI/NCI MSDs.
- 3 Check the vacuum gauge controller to verify correct pressure. See [page 124](#).
- 4 Select **Methane Pretune** from the Setup menu.

The methane pretune tunes the instrument for optimum monitoring of the ratio of methane reagent ions m/z 28/27.

- 5 Examine the displayed profile scan of the reagent ions ([Figure 29](#)).
 - Make sure there is no visible peak at m/z 32. A peak there indicates an air leak. If such a peak is present, find and repair the leak before proceeding. Operating in the CI mode with an air leak will rapidly contaminate the ion source.
 - Make sure that the peak at m/z 19 (protonated water) is less than 50% of the peak at m/z 17.
- 6 Perform the Methane Flow Adjust.

4 Operating in Chemical Ionization (CI) Mode

CAUTION

Continuing with CI autotune if the MSD has an air leak or large amounts of water will result in **severe** ion source contamination. If this happens, you will need to **vent the MSD** and **clean the ion source**.

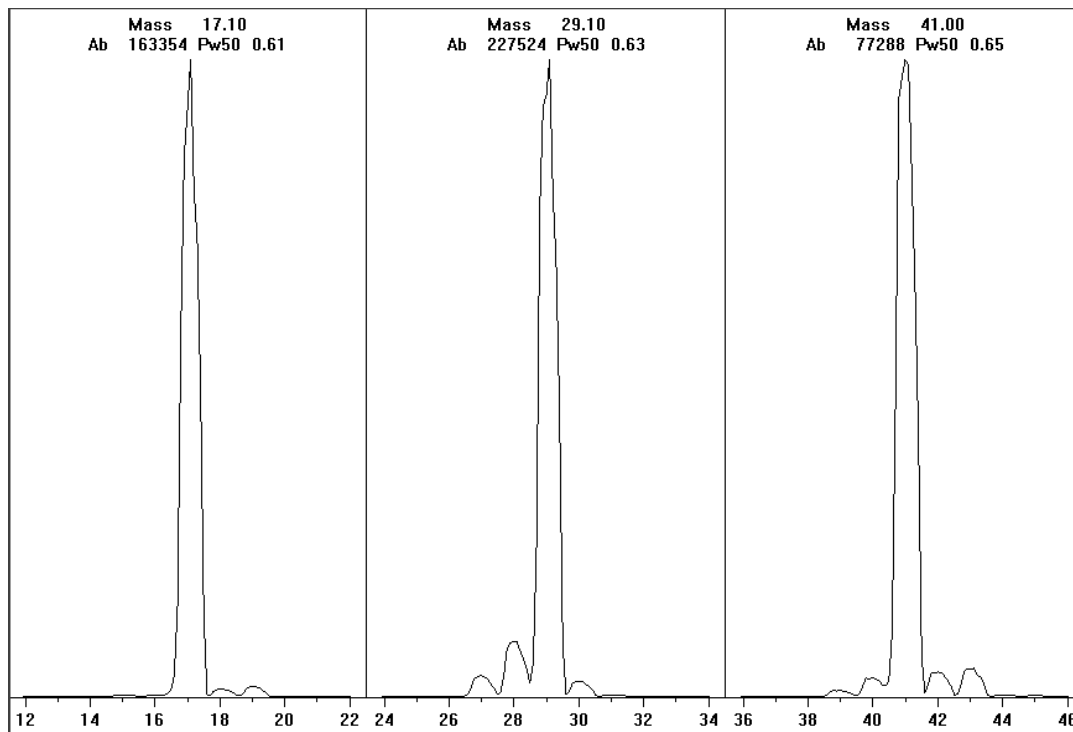

Figure 29 Reagent ion scans

Methane pretune after more than a day of baking out

Note the low abundance of m/z 19 and absence of any visible peak at m/z 32. Your MSD will probably show more water at first, but the abundance of m/z 19 should still be less than 50% of m/z 17.

To use other reagent gases

This section describes the use of isobutane or ammonia as the reagent gas. You should be familiar with operating the CI-equipped 5975 Series MSD with methane reagent gas before attempting to use other reagent gases.

CAUTION

Do not use nitrous oxide as a reagent gas. It radically shortens the life span of the filament.

Changing the reagent gas from methane to either isobutane or ammonia changes the chemistry of the ionization process and yields different ions. The principal chemical ionization reactions encountered are described in general in *Appendix A*, “Chemical Ionization Theory. If you are not experienced with chemical ionization, we suggest reviewing that material before you proceed.

CAUTION

Not all setup operations can be performed in all modes with all reagent gases. See [Table 18](#) for details.

4 Operating in Chemical Ionization (CI) Mode

Table 18 Reagent gases

Reagent gas/mode	Reagent ion masses	PFDTD Calibrant ions	Flow adj ions: Ratio EI/PCI/NCI MSD Performance turbo pump Recommended flow: 20% PCI 40% NCI
Methane/PCI	17, 29, 41 [*]	41, 267, 599	28/27: 1.5 – 5.0
Methane/NCI	17, 35, 235 [†]	185, 351, 449	N/A
Isobutane/PCI	39, 43, 57	N/A	57/43: 5.0 – 30.0
Isobutane/NCI	17, 35, 235	185, 351, 449	N/A
Ammonia/PCI	18, 35, 52	N/A	35/18: 0.1 – 1.0
Ammonia/NCI	17, 35, 235	185, 351, 517	N/A

* There are no PFDTD ions formed with any reagent gas but methane. Tune with methane and use the same parameters for the other gas.

† There are no **negative** reagent gas ions formed. To pretune in negative mode, use background ions: 17 (OH⁻), 35 (Cl⁻), and 235 (ReO₃⁻). These ions can not be used for reagent gas flow adjustment. Set flow to 40% for NCI and adjust as necessary to get acceptable results for your application.

Isobutane CI

Isobutane (C₄H₁₀) is commonly used for chemical ionization when less fragmentation is desired in the chemical ionization spectrum. This is because the proton affinity of isobutane is higher than that of methane; hence less energy is transferred in the ionization reaction.

Addition and proton transfer are the ionization mechanisms most often associated with isobutane. The sample itself influences which mechanism dominates.

Ammonia CI

Ammonia (NH_3) is commonly used for chemical ionization when less fragmentation is desired in the chemical ionization spectrum. This is because the proton affinity of ammonia is higher than that of methane; hence less energy is transferred in the ionization reaction.

Because many compounds of interest have insufficient proton affinities, ammonia chemical-ionization spectra often result from the addition of NH_4^+ and then, in some cases, from the subsequent loss of water. Ammonia reagent ion spectra have principal ions at m/z 18, 35, and 52, corresponding to NH_4^+ , $\text{NH}_4(\text{NH}_3)^+$, and $\text{NH}_4(\text{NH}_3)_2^+$.

To adjust your MSD for isobutane or ammonia chemical ionization, use the following procedure:

Procedure

- 1 From the Tune and Vacuum Control view, perform a standard Positive CI autotune with methane and PFDTD.
- 2 Under the Setup menu, click **CI Tune Wizard** and when prompted select **Isobutane** or **Ammonia**. This will change the menus to use the selected gas and select appropriate default tune parameters.
- 3 Select **Gas B**. Follow the instructions and prompts from the Tune Wizard and set the gas flow to 20%.

If you use an existing tune file, be sure to save it with a new name if you don't want to overwrite the existing values. Accept the default temperature and other settings.

- 4 Click **Isobutane** (or **Ammonia**) **Flow Adjust** on the Setup menu.

There is no CI autotune for isobutane or ammonia in PCI.

If you wish to run NCI with isobutane or ammonia, load **NCICH4.U** or an existing NCI tune file for the specific gas.

NOTE

Be sure to read the following application note: *Implementation of Ammonia Reagent Gas for Chemical Ionization on the Agilent 5975 Series MSDs (5989-5170EN)*.

4 Operating in Chemical Ionization (CI) Mode

CAUTION

Use of ammonia affects the maintenance requirements of the MSD. See “[CI Maintenance](#)” for more information.

CAUTION

The pressure of the ammonia supply must be less than 5 psig. Higher pressures can result in ammonia condensing from a gas to a liquid.

Always keep the ammonia tank in an upright position, below the level of the flow module. Coil the ammonia supply tubing into several vertical loops by wrapping the tubing around a can or bottle. This will help keep any liquid ammonia out of the flow module.

Ammonia tends to break down vacuum pump fluids and seals. Ammonia CI makes more frequent vacuum system maintenance necessary. (See the 5975 Series MSD Troubleshooting and Maintenance Manual.)

CAUTION

When running ammonia for 5 or more hours a day, the foreline pump must be ballasted (flushed with air) for at least 1 hour a day to minimize damage to pump seals. Always purge the MSD with methane after flowing ammonia.

Frequently, a mixture of 5% ammonia and 95% helium or 5% ammonia and 95% methane is used as a CI reagent gas. This is enough ammonia to achieve good chemical ionization while minimizing its negative effects.

Carbon dioxide CI

Carbon dioxide is often used as a reagent gas for CI. It has obvious advantages of availability and safety.

To switch from the CI source to the EI source

Procedure

- 1 From the Tune and Vacuum Control view, vent the MSD. See [page 82](#). The software will prompt you for the appropriate actions.
- 2 Open the analyzer.
- 3 Remove the CI interface tip seal. See [page 143](#).
- 4 Remove the CI ion source. See [page 142](#).
- 5 Install the EI ion source. See [page 136](#).
- 6 Place the CI ion source and interface tip seal in the ion source storage box.
- 7 Pump down the MSD. See [page 91](#).
- 8 Load your EI tune file.

CAUTION

Always wear clean gloves while touching the analyzer or any other parts that go inside the analyzer chamber.

CAUTION

Electrostatic discharges to analyzer components are conducted to the side board where they can damage sensitive components. Wear a grounded antistatic wrist strap and take other antistatic precautions **before** you open the analyzer chamber. See [page 131](#).

CI Autotune

After the reagent gas flow is adjusted, the lenses and electronics of the MSD should be tuned ([Table 19](#)). Perfluoro-5,8-dimethyl-3,6,9-trioxidodecane (PFDTD) is used as the calibrant. Instead of flooding the entire vacuum chamber, the PFDTD is introduced directly into the ionization chamber through the GC/MSD interface by means of the gas flow control module.

CAUTION

After the source is changed from EI to CI or vented for any other reason, the MSD must be purged and baked out for at least 2 hours before tuning. Longer bakeout is recommended before running samples requiring optimal sensitivity.

There is a PCI autotune for methane only, as there are no PFDTD ions produced by other gases in positive mode. PFDTD ions are visible in NCI for any reagent gas. Always tune for methane PCI first regardless of which mode or reagent gas you wish to use for your analysis.

There are no tune performance criteria. If CI autotune completes, it passes.

EMVolts (electron multiplier voltage) at or above 2600 V, however, indicates a problem. If your method requires EMVolts set at +400, you may not have adequate sensitivity in your data acquisition.

CAUTION

Always verify MSD performance in EI before switching to CI operation. See [page 76](#). Always set up the CI MSD in PCI first, even if you are going to run NCI.

Table 19 Reagent gas settings

Reagent gas	Methane		Isobutane		Ammonia		EI
Ion polarity	Positive	Negative	Positive	Negative	Positive	Negative	N/A
Emission	150 μ A	50 μ A	150 μ A	50 μ A	150 μ A	50 μ A	35 μ A
Electron energy	150 eV	150 eV	150 eV	150 eV	150 eV	150 eV	70 eV
Filament	1	1	1	1	1	1	1 or 2
Repeller	3 V	3 V	3 V	3 V	3 V	3 V	30 V
Ion focus	130 V	130 V	130 V	130 V	130 V	130 V	90 V
Entrance lens offset	20 V	20 V	20 V	20 V	20 V	20 V	25 V
EM volts	1200	1400	1200	1400	1200	1400	1300
Shutoff valve	Open	Open	Open	Open	Open	Open	Closed
Gas select	A	A	B	B	B	B	None
Suggested flow	20%	40%	20%	40%	20%	40%	N/A
Source temp	250 °C	150 °C	250 °C	150 °C	250 °C	150 °C	230 °C
Quad temp	150 °C	150 °C	150 °C	150 °C	150 °C	150 °C	150 °C
Interface temp	280 °C	280 °C	280 °C	280 °C	280 °C	280 °C	280 °C
Autotune	Yes	Yes	No	Yes	No	Yes	Yes

N/A Not available

To perform a PCI autotune (methane only)

CAUTION

Always verify MSD performance in EI before switching to CI operation. See [page 76](#). Always set up the CI MSD in PCI first, even if you are going to run NCI.

Procedure

- 1 Verify that the MSD performs correctly in EI mode first. See [page 76](#).
- 2 Load the **PCICH4.U** tune file (or an existing tune file for the reagent gas you are using).

If you use an existing tune file, be sure to save it with a new name if you don't want to overwrite the existing values.

- 3 Accept the default settings.
- 4 Perform methane setup. See [page 109](#).
- 5 Under the Tune menu, click **CI Autotune**.

CAUTION

Avoid tuning more often than is absolutely necessary; this will minimize PFDTD background noise and help prevent ion source contamination.

There are no tune performance criteria. If autotune completes, it passes ([Figure 30](#)). If the tune sets the electron multiplier voltage (EMVolts) at or above 2600 V, however, you may not be able to acquire data successfully if your method sets EMVolts to “+400” or higher.

The autotune report contains information about air and water in the system.

The 19/29 ratio shows the abundance of water.

The 32/29 ratio shows the abundance of oxygen.

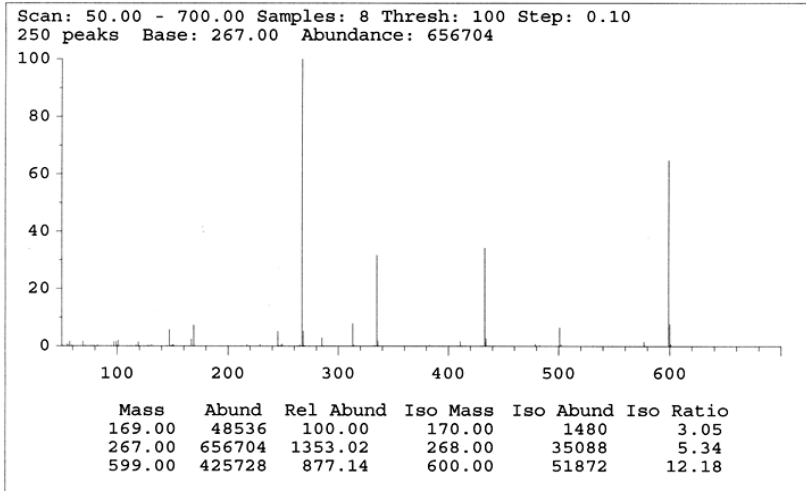
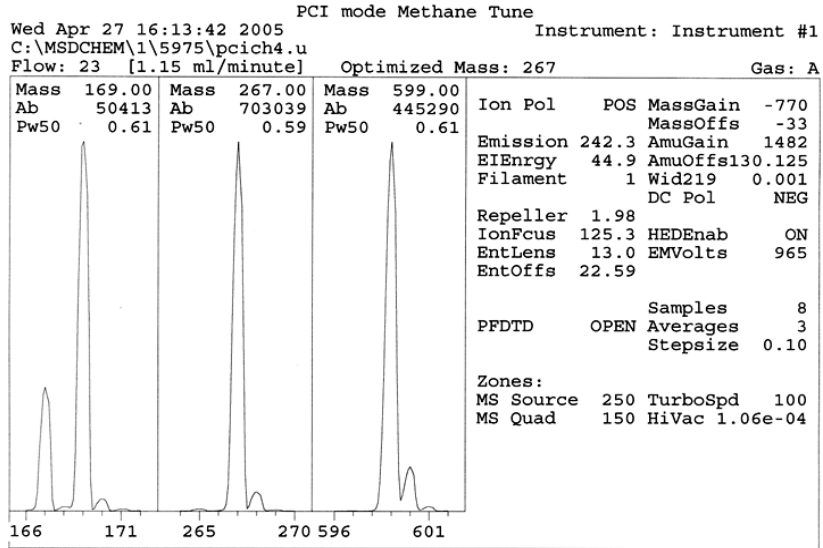

CI Reagent Ions: 17/29 Ratio: 0.43 19/29 Ratio: 0.09 32/29 Ratio: 0.00
 28/27 Ratio: 4.0 28/29 Ratio: 0.08
 41/29 Ratio: 0.36 29 Abundance: 1223168 counts

Figure 30 PCI autotune

To perform an NCI autotune (methane reagent gas)

CAUTION

Always verify MSD performance in EI before switching to CI operation. See [page 76](#). Always set up the CI MSD in PCI with methane as the reagent gas first, even if you are going to be using a different reagent gas or going to run NCI.

Procedure

- 1 From the Tune and Vacuum Control view, load **NCICH4.U** (or an existing tune file for the reagent gas you are using).
- 2 From the Setup menu select the **CI Tune Wizard** and follow the system prompts.

Accept the default temperature and other settings.

If you use an existing tune file, be sure to save it with a new name if you don't want to overwrite the existing values.

- 3 Under the Tune menu, click **CI Autotune**.

CAUTION

Avoid tuning unless absolutely necessary; this will minimize PFDTD background noise and help prevent ion source contamination.

There are no tune performance criteria. If autotune completes, it passes ([Figure 31](#)). If the tune sets the electron multiplier voltage (EMVolts) at or above 2600 V, however, you may not be able to acquire data successfully if your method sets EMVolts to "+400" or higher.

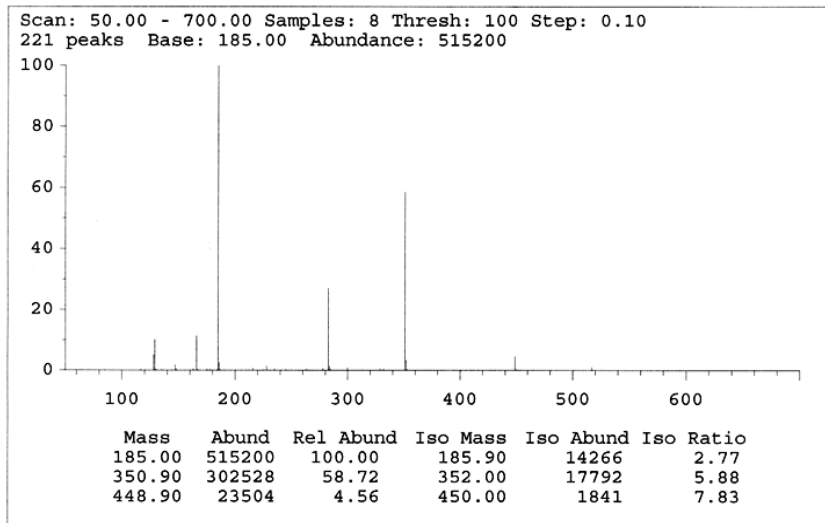
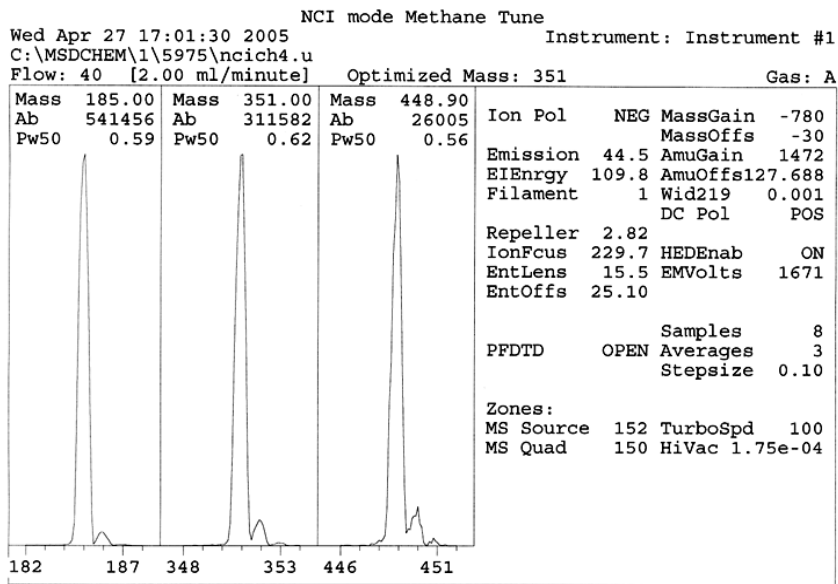

Figure 31 NCI autotune

To verify PCI performance

Materials needed

- Benzophenone, 100 pg/μL (8500-5440)

CAUTION

Always verify MSD performance in EI before switching to CI operation. See [page 76](#). Always set up the CI MSD in PCI first, even if you are going to run NCI.

Procedure

- 1 Verify that the MSD performs correctly in EI mode.
- 2 Verify that the **PCICH4.U** tune file is loaded.
- 3 Select **Gas A** and set flow to 20%.
- 4 In Tune and Vacuum Control view, perform CI setup. See [page 116](#).
- 5 Run CI Autotune. See [page 116](#).
- 6 Run the PCI sensitivity method **BENZ_PCI.M** using 1 μL of 100 pg/μL benzophenone.
- 7 Verify that the system conforms to the published sensitivity specification. Please see the Agilent Web site at www.agilent.com/chem for specifications.

To verify NCI performance

This procedure is for EI/PCI/NCI MSDs only.

Materials needed

- Octafluoronaphthalene (OFN), 100 fg/μL (5188-5347)

CAUTION

Always verify MSD performance in EI before switching to CI operation. See [page 76](#). Always set up the CI MSD in PCI first, even if you are going to run NCI.

Procedure

- 1 Verify that the MSD performs correctly in EI mode.
- 2 Load the **NCICH4.U** tune file, and accept the temperature setpoints.
- 3 Select **Gas A** and set flow to 40%.
- 4 In Tune and Vacuum Control view, run CI Autotune. See [page 120](#).
Note that there are no criteria for a “passing” Autotune in CI. If the Autotune completes, it passes.
- 5 Run the NCI sensitivity method: OFN_NCI.M using 2 μL of 100 fg/μL OFN.
- 6 Verify that the system conforms to the published sensitivity specification. Please see the Agilent Web site at www.agilent.com/chem for specifications.

To monitor high vacuum pressure

WARNING

If you are using hydrogen as a carrier gas, do not turn on the Micro-Ion vacuum gauge if there is any possibility that hydrogen has accumulated in the manifold. Read “Hydrogen Safety” before operating the MSD with hydrogen carrier gas.

Procedure

- 1 Start up and pump down the MSD. See [page 103](#).
- 2 In the Tune and Vacuum Control view select **Turn Vacuum Gauge on/off** from the Vacuum menu.
- 3 In the Instrument Control view you can set up an MS Monitor for reading. The vacuum can also be read on the LCP or from the Manual Tune screen.

The gauge controller will not turn on if the pressure in the MSD is above approximately 8×10^{-3} Torr. The gauge controller is calibrated for nitrogen, but all pressures listed in this manual are for helium.

The largest influence on operating pressure is the carrier gas (column) flow. [Table 20](#) lists typical pressures for various helium carrier gas flows. These pressures are approximate and will vary from instrument to instrument.

Typical pressure readings

Use the G3397A Micro-Ion vacuum gauge. Note that the mass flow controller is calibrated for methane and the vacuum gauge is calibrated for nitrogen, so these measurements are not accurate, but are intended as a guide to typical observed readings (Table 20). They were taken with the following set of conditions. Note that these are typical PCI temperatures:

Source temperature	250 °C
Quad temperature	150 °C
Interface temperature	280 °C
Helium carrier gas flow	1 mL/min

Table 20 Flow and pressure readings

Pressure (Torr)		
	Methane	Ammonia
MFC (%)	EI/PCI/NCI MSD (Performance turbo pump)	EI/PCI/NCI MSD (Performance turbo pump)
10	5.5×10^{-5}	5.0×10^{-5}
15	8.0×10^{-5}	7.0×10^{-5}
20	1.0×10^{-4}	8.5×10^{-5}
25	1.2×10^{-4}	1.0×10^{-4}
30	1.5×10^{-4}	1.2×10^{-4}
35	2.0×10^{-4}	1.5×10^{-4}
40	2.5×10^{-4}	2.0×10^{-4}

Familiarize yourself with the measurements on your system under operating conditions and watch for changes that may indicate a vacuum or gas flow problem. Measurements will vary by as much as 30% from one MSD and gauge controller to the next.

4 Operating in Chemical Ionization (CI) Mode

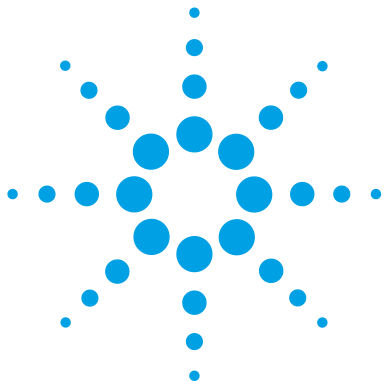

5 General Maintenance

Before Starting 128

Maintaining the Vacuum System 133



Before Starting

You can perform much of the maintenance required by your MSD. For your safety, read all of the information in this introduction before performing any maintenance tasks.

Scheduled maintenance

Common maintenance tasks are listed in [Table 21](#). Performing these tasks when scheduled can reduce operating problems, prolong system life, and reduce overall operating costs.

Keep a record of system performance (tune reports) and maintenance operations performed. This makes it easier to identify variations from normal operation and to take corrective action.

Table 21 Maintenance schedule

Task	Every week	Every 6 months	Every year	As needed
Tune the MSD				X
Check the foreline pump oil level	X			
Check the calibration vial(s)		X		
Replace the foreline pump oil*		X		
Replace the diffusion pump fluid			X	
Check the dry foreline pump				X
Clean the ion source				X
Check the carrier gas trap(s) on the GC and MSD				X
Replace the worn out parts				X
Lubricate sideplate or vent valve O-rings†				X
Replace CI Reagent gas supply				X
Replace GC gas supplies				X

* Every 3 months for CI MSDs using ammonia reagent gas.

† Vacuum seals other than the side plate O-ring and vent valve O-ring do not need to be lubricated. Lubricating other seals can interfere with their correct function.

Tools, spare parts, and supplies

Some of the required tools, spare parts, and supplies are included in the GC shipping kit, MSD shipping kit, or MSD tool kit. You must supply others yourself. Each maintenance procedure includes a list of the materials required for that procedure.

High voltage precautions

Whenever the MSD is plugged in, even if the power switch is off, potentially dangerous voltage (120 VAC or 200/240 VAC) exists on:

- The wiring and fuses between where the power cord enters the instrument and the power switch

When the power switch is on, potentially dangerous voltages exist on:

- Electronic circuit boards
- Toroidal transformer
- Wires and cables between these boards
- Wires and cables between these boards and the connectors on the back panel of the MSD
- Some connectors on the back panel (for example, the foreline power receptacle)

Normally, all of these parts are shielded by safety covers. As long as the safety covers are in place, it should be difficult to accidentally make contact with dangerous voltages.

WARNING

Perform no maintenance with the MSD turned on or plugged into its power source unless you are instructed to by one of the procedures in this chapter.

Some procedures in this chapter require access to the inside of the MSD while the power switch is on. Do not remove any of the electronics safety covers in any of these procedures. To reduce the risk of electric shock, follow the procedures carefully.

Dangerous temperatures

Many parts in the MSD operate at, or reach, temperatures high enough to cause serious burns. These parts include, but are not limited to:

- GC/MSD interface
- Analyzer parts
- Vacuum pumps

WARNING

Never touch these parts while your MSD is on. After the MSD is turned off, give these parts enough time to cool before handling them.

WARNING

The GC/MSD interface heater is powered by a thermal zone on the GC. The interface heater can be on, and at a dangerously high temperature, even though the MSD is off. The GC/MSD interface is well insulated. Even after it is turned off, it cools very slowly.

WARNING

The foreline pump can cause burns if touched when operating. It has a safety shield to prevent the user from touching it.

The GC inlets and GC oven also operate at very high temperatures. Use the same caution around these parts. See the documentation supplied with your GC for more information.

Chemical residue

Only a small portion of your sample is ionized by the ion source. The majority of any sample passes through the ion source without being ionized. It is pumped away by the vacuum system. As a result, the exhaust from the foreline pump will contain traces of the carrier gas and your samples. Exhaust from the standard foreline pump also contains tiny droplets of foreline pump oil.

An oil trap is supplied with the standard foreline pump. This trap stops only pump oil droplets. It does not trap any other chemicals. If you are using toxic solvents or analyzing toxic chemicals, do not use this oil trap. For all foreline

pumps, install a hose to take the exhaust from the foreline pump outdoors or into a fume hood vented to the outdoors. For the standard foreline pump, this requires removing the oil trap. Be sure to comply with your local air quality regulations.

WARNING

The oil trap supplied with the standard foreline pump stops only foreline pump oil. It does not trap or filter out toxic chemicals. If you are using toxic solvents or analyzing toxic chemicals, remove the oil trap. Do not use the trap if you have a CI MSD. Install a hose to take the foreline pump exhaust outside or to a fume hood.

The fluids in the diffusion pump and standard foreline pump also collect traces of the samples being analyzed. All used pump fluid should be considered hazardous and handled accordingly. Dispose of used fluid correctly, as specified by your local regulations.

WARNING

When replacing pump fluid, use appropriate chemical-resistant gloves and safety glasses. Avoid all contact with the fluid.

Electrostatic discharge

All of the printed circuit boards in the MSD contain components that can be damaged by electrostatic discharge (ESD). Do not handle or touch these boards unless absolutely necessary. In addition, wires, contacts, and cables can conduct ESD to the electronics boards to which they are connected. This is especially true of the mass filter (quadrupole) contact wires which can carry ESD to sensitive components on the side board. ESD damage may not cause immediate failure but it will gradually degrade the performance and stability of your MSD.

When you work on or near printed circuit boards or when you work on components with wires, contacts, or cables connected to printed circuit boards, always use a grounded antistatic wrist strap and take other antistatic precautions. The wrist strap should be connected to a known good earth ground. If that is not possible, it should be connected to a conductive (metal) part of the assembly being worked on, but not to electronic components, exposed wires or traces, or pins on connectors.

5 General Maintenance

Take extra precautions, such as a grounded antistatic mat, if you must work on components or assemblies that have been removed from the MSD. This includes the analyzer.

CAUTION

To be effective, an antistatic wrist strap must fit snugly (not tight). A loose strap provides little or no protection.

Antistatic precautions are not 100% effective. Handle electronic circuit boards as little as possible and then only by the edges. Never touch components, exposed traces, or pins on connectors and cables.

Maintaining the Vacuum System

Periodic maintenance

As listed earlier in [Table 21](#), some maintenance tasks for the vacuum system must be performed periodically. These include:

- Checking the foreline pump fluid (every week)
- Checking the calibration vial(s) (every 6 months)
- Ballasting the foreline pump (daily in MSDs using ammonia reagent gas)
- Replacing the foreline pump oil (every 6 months; every 3 months for CI MSDs using ammonia reagent gas)
- Tightening the foreline pump oil box screws (first oil change after installation)
- Replacing the diffusion pump fluid (once a year)
- Replacing the dry foreline pump (typically every 3 years)

Failure to perform these tasks as scheduled can result in decreased instrument performance. It can also result in damage to your instrument.

Other procedures

Tasks such as replacing a foreline vacuum gauge or Micro-Ion vacuum gauge should be performed only when needed. See the *5975 Series MSD Troubleshooting and Maintenance* manual and see the online help in the MSD ChemStation software for symptoms that indicate this type of maintenance is required.

More information is available

If you need more information about the locations or functions of vacuum system components, see the *5975 Series MSD Troubleshooting and Maintenance* manual.

Most of the procedures in this chapter are illustrated with video clips on the Agilent GC/GCMSD Hardware User Information & Instrument Utilities and 5975 Series MSD User Information disks.

To remove the EI ion source

Materials needed

- Gloves, clean, lint-free
 - Large (8650-0030)
 - Small (8650-0029)
- Pliers, long-nose (8710-1094)



Procedure

- 1 Vent the MSD. See [page 82](#).
- 2 Open the analyzer chamber. See [page 84](#).

Make sure you use an antistatic wrist strap and take other antistatic precautions before touching analyzer components.

- 3 Disconnect the seven wires from the ion source. Do not bend the wires any more than necessary ([Figure 32](#) and [Table 22](#)).

Table 22 Ion source wires

Wire color	Connects to	Number of leads
Blue	Entrance lens	1
Orange	Ion focus	1
White	Filament 1 (top filament)	2
Red	Repeller	1
Black	Filament 2 (bottom filament)	2

CAUTION

Pull on the connectors, not on the wires.

- 4 Trace the wires for the ion source heater and temperature sensor to the feedthrough board. Disconnect them there.
- 5 Remove the thumbscrews that hold the ion source in place.
- 6 Pull the ion source out of the source radiator.

WARNING

The analyzer operates at high temperatures. Do not touch any part until you are sure it is cool.

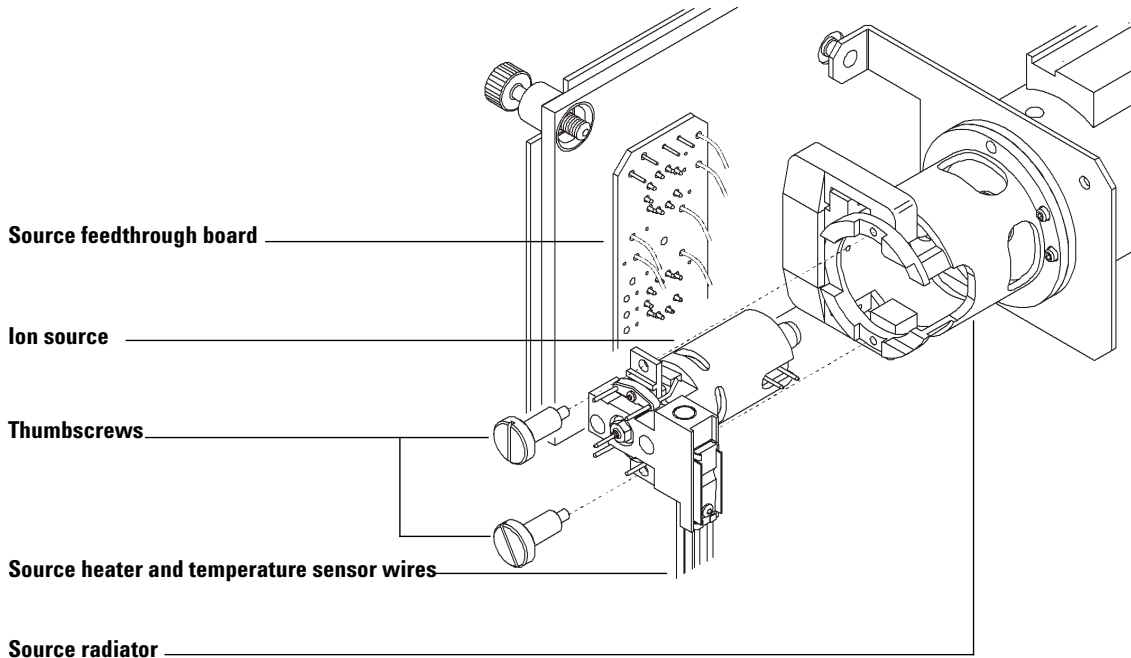

Figure 32 Removing the ion source

To reinstall the EI ion source

Materials needed

- Gloves, clean, lint-free
 - Large (8650-0030)
 - Small (8650-0029)
- Pliers, long-nose (8710-1094)

Procedure



- 1** Slide the ion source into the source radiator ([Figure 33](#)).
- 2** Install and hand tighten the source thumbscrews. Do not overtighten the thumbscrews.
- 3** Connect the ion source wires as shown in [“To close the analyzer chamber”](#) . Close the analyzer chamber.

- 4 Pump down the MSD. See [page 91](#).

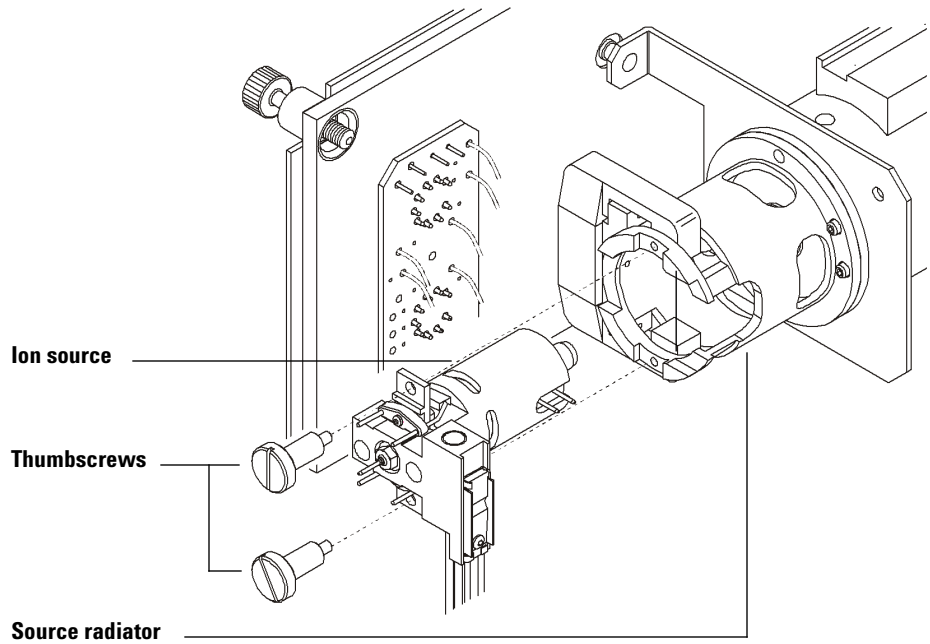
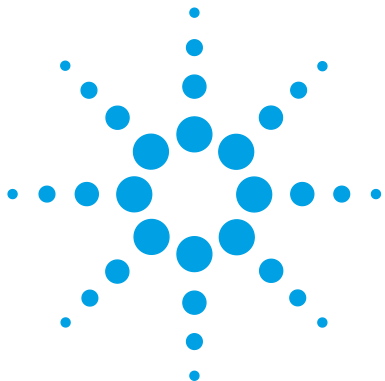

Figure 33 Installing the EI ion source



6 CI Maintenance

General Information	140
Ion source cleaning	140
Ammonia	140
To Set Up Your MSD for CI Operation	141
Guidelines	141
To install the CI ion source	142
To install the CI interface tip seal	143

This chapter describes maintenance procedures and requirements that are unique to 5975 Series MSDs equipped with the Chemical Ionization hardware.



General Information

Ion source cleaning

The main effect of operating the MSD in CI mode is the need for more frequent ion source cleaning. In CI operation, the ion source chamber is subject to more rapid contamination than in EI operation because of the higher source pressures required for CI.

WARNING

Always perform any maintenance procedures using hazardous solvents under a fume hood. Be sure to operate the MSD in a well-ventilated room.

Ammonia

Ammonia, used as a reagent gas, increases the need for foreline pump maintenance. Ammonia causes foreline pump oil to break down more quickly. Therefore, the oil in the standard foreline vacuum pump must be checked and replaced more frequently.

Always purge the MSD with methane after using ammonia.

Be sure to install the ammonia so the tank is in an upright position. This will help prevent liquid ammonia from getting into the flow module.

To Set Up Your MSD for CI Operation

Setting up your MSD for operation in CI mode requires special care to avoid contamination and air leaks.

Guidelines

- Before venting in EI mode, verify that the GC/MSD system is performing correctly. See [“To verify system performance”](#) .
- Make sure the reagent gas inlet line(s) are equipped with gas purifiers (not applicable for ammonia).
- Use extra-high purity reagent gases; 99.99% or better for methane and as pure as is available for other reagent gases.

To install the CI ion source

CAUTION

Electrostatic discharges to analyzer components are conducted to the side board where they can damage sensitive components. Wear a grounded antistatic wrist strap and take other antistatic precautions **before** you open the analyzer chamber.

Procedure



- 1 Vent the MSD and open the analyzer. See [page 84](#).
- 2 Remove the EI ion source. See [page 134](#).
- 3 Remove the CI ion source from its storage box and insert the ion source into the radiator.
- 4 Reinstall the thumbscrews ([Figure 34](#)).
- 5 Connect the wiring as described in “[To close the analyzer chamber](#)”.

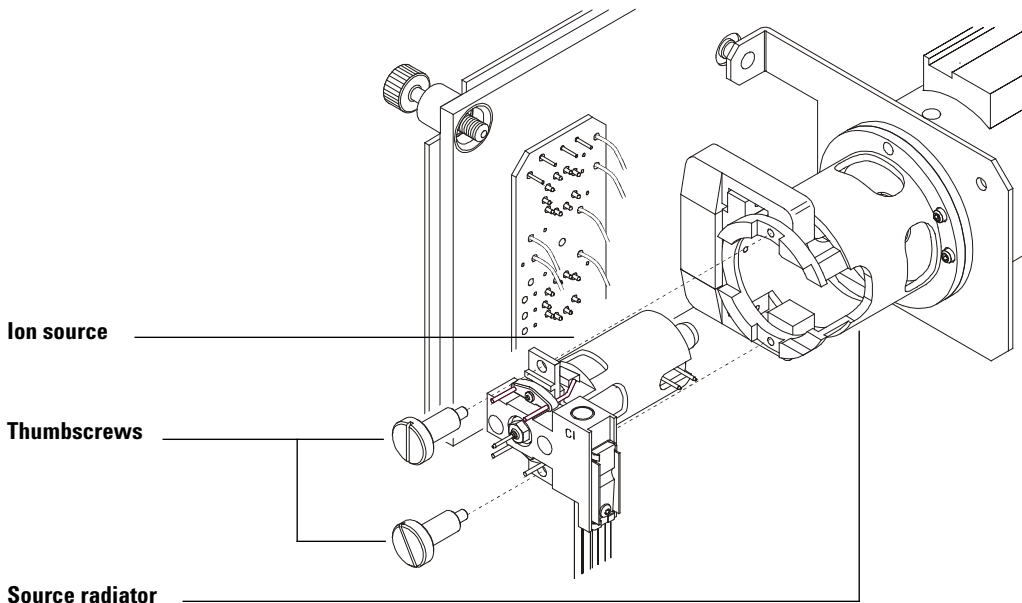

Figure 34 Installing the CI ion source

To install the CI interface tip seal

Materials needed

- Interface tip seal (G1099-60412)

The interface tip seal must be in place for CI operation. It is necessary to achieve adequate ion source pressure for CI.

CAUTION

Electrostatic discharges to analyzer components are conducted to the side board where they can damage sensitive components. Wear a grounded antistatic wrist strap and take other antistatic precautions **before** you open the analyzer chamber.

Procedure

- 1 Remove the seal from the ion source storage box.
- 2 Verify that the CI ion source is installed.
- 3 Place the seal over the end of the interface. To remove the seal, reverse the above steps.
- 4 Gently check the alignment of the analyzer and the interface.



When the analyzer is aligned correctly, the analyzer can be closed all the way with no resistance except the spring tension from the interface tip seal.

CAUTION

Forcing the analyzer closed if these parts are misaligned will damage the seal or the interface or the ion source, or will keep the sideplate from sealing.

- 5 You can align the analyzer and interface by wiggling the side plate on its hinge. If the analyzer still will not close, contact your Agilent Technologies service representative.

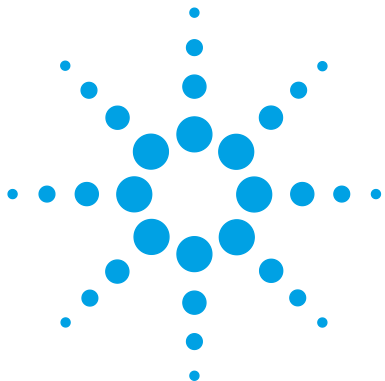

A Chemical Ionization Theory

Chemical Ionization Overview 146

Positive CI Theory 148

Negative CI Theory 155



Chemical Ionization Overview

Chemical ionization (CI) is a technique for creating ions used in mass spectrometric analyses. There are significant differences between CI and electron ionization (EI). This section describes the most common chemical ionization mechanisms.

In EI, relatively high-energy electrons (70 eV) collide with molecules of the sample to be analyzed. These collisions produce (primarily) positive ions. Upon ionization, the molecules of a given substance fragment in fairly predictable patterns. EI is a direct process; energy is transferred by collision from electrons to the sample molecules.

For CI, in addition to the sample and carrier gas, large amounts of reagent gas are introduced into the ionization chamber. Since there is so much more reagent gas than sample, most of the emitted electrons collide with reagent gas molecules, forming reagent ions. These reagent-gas ions react with each other in primary and secondary reaction processes that establish an equilibrium. They also react in various ways with sample molecules to form sample ions. CI ion formation involves much lower energy and is much more “gentle” than electron ionization. Since CI results in much less fragmentation, CI spectra usually show high abundance of the molecular ion. For this reason, CI is often used to determine the molecular weights of sample compounds.

Methane is the most common CI reagent gas. It yields certain characteristic ionization patterns. Other reagent gases yield different patterns and may result in better sensitivity for some samples. Common alternative reagent gases are isobutane and ammonia. Carbon dioxide is often used in negative CI. Less common reagent gases are carbon dioxide, hydrogen, Freon, trimethylsilane, nitric oxide, and methylamine. Different ionization reactions occur with each reagent gas.

WARNING

Ammonia is toxic and corrosive. Use of ammonia requires special maintenance and safety precautions.

Water contamination in reagent gases will decrease CI sensitivity dramatically. A large peak at m/z 19 (H_3O^+) in positive CI is a diagnostic symptom of water contamination. In high enough concentrations, especially when combined with calibrant, water contamination will result in a heavily

contaminated ion source. Water contamination is most common immediately after new reagent gas tubing or reagent gas cylinders are connected. This contamination will often decrease if the reagent gas is allowed to flow for a few hours, purging the system.

References on chemical ionization

A. G. Harrison, *Chemical Ionization Mass Spectrometry*, 2nd Edition, CRC Press, INC. Boca Raton, FL (1992) ISBN 0-8493-4254-6.

W. B. Knighton, L. J. Sears, E. P. Grimsrud, "High Pressure Electron Capture Mass Spectrometry", *Mass Spectrometry Reviews* (1996), **14**, 327-343.

E. A. Stemmler, R. A. Hites, *Electron Capture Negative Ion Mass Spectra of Environmental Contaminants and Related Compounds*, VCH Publishers, New York, NY (1988) ISBN 0-89573-708-6.

Positive CI Theory

Positive CI (PCI) occurs with the same analyzer voltage polarities as EI. For PCI, the reagent gas is ionized by collision with emitted electrons. The reagent gas ions react chemically with sample molecules (as proton donors) to form sample ions. PCI ion formation is more “gentle” than electron ionization, producing less fragmentation. This reaction usually yields high abundance of the molecular ion and is therefore often used for determining molecular weights of samples.

The most common reagent gas is methane. Methane PCI produces ions with almost any sample molecule. Other reagent gases, such as isobutane or ammonia, are more selective and cause even less fragmentation. Because of the high background from the reagent gas ions, PCI is not especially sensitive and detection limits are generally high.

There are four fundamental ionization processes that take place during positive chemical ionization at ion source pressures in the 0.8 to 2.0 Torr range. These are:

- Proton transfer
- Hydride abstraction
- Addition
- Charge exchange

Depending on the reagent gas used, one or more of these four processes can be used to explain the ionization products observed in the resulting mass spectra.

EI, methane PCI, and ammonia PCI spectra of methyl stearate are shown in [Figure 35](#). The simple fragmentation pattern, large abundance of the $[MH]^+$ ion, and the presence of the two adduct ions are characteristic of positive chemical ionization using methane as a reagent gas.

The presence of air or water in the system, especially in the presence of PFDTD calibrant, quickly contaminates the ion source.

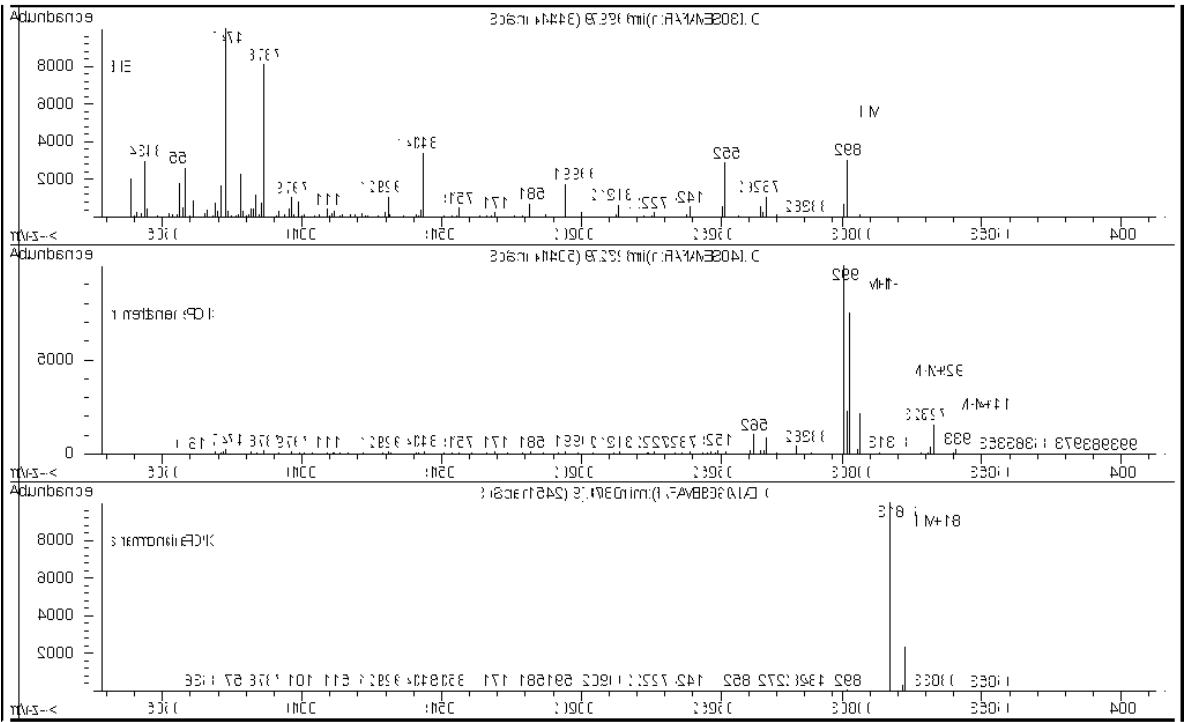
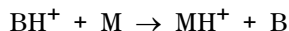

Figure 35 Methyl stearate (MW = 298): EI, methane PCI, and ammonia PCI

Proton transfer

Proton transfer can be expressed as



where the reagent gas B has undergone ionization resulting in protonation. If the proton affinity of the analyte (sample) M is greater than that of the reagent gas, then the protonated reagent gas will transfer its proton to the analyte forming a positively charged analyte ion.

The most frequently used example is the proton transfer from CH_5^+ to the molecular analyte, which results in the protonated molecular ion MH^+ .

The relative proton affinities of the reagent gas and the analyte govern the proton transfer reaction. If the analyte has a greater proton affinity than the reagent gas, then proton transfer can take place. Methane (CH_4) is the most common reagent gas because its proton affinity is very low.

Proton affinities can be defined according to the reaction:

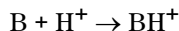

where the proton affinities are expressed in kcal/mole. Methane's proton affinity is 127 kcal/mole. Tables 23 and 24 list the proton affinities of several possible reagent gases and of several small organic compounds with various functional groups.

The mass spectrum generated by a proton-transfer reaction depends on several criteria. If the difference in proton affinities is large (as with methane), substantial excess energy may be present in the protonated molecular ion. This can result in subsequent fragmentation. For this reason, isobutane with a proton affinity of 195 kcal/mole may be preferred to methane for some analyses. Ammonia has a proton affinity of 207 kcal/mole, making it less likely to protonate most analytes. Proton-transfer chemical ionization is usually considered to be “soft” ionization, but the degree of the softness depends on the proton affinities of both the analyte and the reagent gas, as well as on other factors including ion source temperature.

Table 23 Reagent gas proton affinities

Species	Proton affinity kcal/mole	Reactant ion formed
H ₂	100	H ₃ ⁺ (<i>m/z</i> 3)
CH ₄	127	CH ₅ ⁺ (<i>m/z</i> 17)
C ₂ H ₄	160	C ₂ H ₅ ⁺ (<i>m/z</i> 29)
H ₂ O	165	H ₃ O ⁺ (<i>m/z</i> 19)
H ₂ S	170	H ₃ S ⁺ (<i>m/z</i> 35)
CH ₃ OH	182	CH ₃ OH ₂ ⁺ (<i>m/z</i> 33)
t-C ₄ H ₁₀	195	t-C ₄ H ₉ ⁺ (<i>m/z</i> 57)
NH ₃	207	NH ₄ ⁺ (<i>m/z</i> 18)

Table 24 Proton affinities of selected organic compounds for PCI

Molecule	Proton affinity (kcal/mole)	Molecule	Proton affinity (kcal/mole)
Acetaldehyde	185	Methyl amine	211
Acetic acid	188	Methyl chloride	165
Acetone	202	Methyl cyanide	186
Benzene	178	Methyl sulfide	185
2-Butanol	197	Methyl cyclopropane	180
Cyclopropane	179	Nitroethane	185
Dimethyl ether	190	Nitromethane	180
Ethane	121	n-Propyl acetate	207
Ethyl formate	198	Propylene	179
Formic acid	175	Toluene	187
Hydrobromic acid	140	<i>trans</i> -2-Butene	180
Hydrochloric acid	141	Trifluoroacetic acid	167

Table 24 Proton affinities of selected organic compounds for PCI (continued)

Molecule	Proton affinity (kcal/mole)	Molecule	Proton affinity (kcal/mole)
Isopropyl alcohol	190	Xylene	187
Methanol	182		

Hydride abstraction

In the formation of reagent ions, various reactant ions can be formed that have high hydride-ion (H^-) affinities. If the hydride-ion affinity of a reactant ion is higher than the hydride-ion affinity of the ion formed by the analyte's loss of H^- , then the thermodynamics are favorable for this chemical ionization process. Examples include the hydride abstraction of alkanes in methane chemical ionization. In methane CI, both CH_5^+ and C_2H_5^+ are capable of hydride abstraction. These species have large hydride-ion affinities, which results in the loss of H^- for long-chain alkanes, according to the general reaction



For methane, R^+ is CH_5^+ and C_2H_5^+ , and M is a long-chain alkane. In the case of CH_5^+ , the reaction proceeds to form $[\text{M}-\text{H}]^+ + \text{CH}_4 + \text{H}_2$. The spectra resulting from hydride abstraction will show an $\text{M}-1$ m/z peak resulting from the loss of H^- . This reaction is exothermic so fragmentation of the $[\text{M}-\text{H}]^+$ ion is often observed.

Often, both hydride-abstraction and proton-transfer ionization can be evident in the sample spectrum. One example is the methane CI spectrum of long-chain methyl esters, where both hydride abstraction from the hydrocarbon chain and proton transfer to the ester function occur. In the methane PCI spectrum of methyl stearate, for example, the MH^+ peak at m/z 299 is created by proton transfer and the $[\text{M}-1]^+$ peak at m/z 297 is created by hydride abstraction.

Addition

For many analytes, proton-transfer and hydride-abstraction chemical ionization reactions are not thermodynamically favorable. In these cases, reagent gas ions are often reactive enough to combine with the analyte molecules by condensation or association (addition reactions). The resulting ions are called adduct ions. Adduct ions are observed in methane chemical ionization by the presence of $[\text{M}+\text{C}_2\text{H}_5]^+$ and $[\text{M}+\text{C}_3\text{H}_5]^+$ ions, which result in $\text{M}+29$ and $\text{M}+41$ m/z mass peaks.

Addition reactions are particularly important in ammonia CI. Because the NH_3 has a high proton affinity, few organic compounds will undergo proton transfer with ammonia reagent gas. In ammonia CI, a series of ion-molecule reactions takes place, resulting in the formation of NH_4^+ , $[\text{NH}_4\text{NH}_3]^+$, and $[\text{NH}_4(\text{NH}_3)_2]^+$. In particular, the ammonium ion, NH_4^+ , will give rise to an

intense $[M+NH_4]^+$ ion observed at $M+18$ m/z , either through condensation or association. If this resulting ion is unstable, subsequent fragmentation may be observed. The neutral loss of H_2O or NH_3 , observed as a subsequent loss of 18 or 17 m/z , respectively, is also common.

Charge exchange

Charge-exchange ionization can be described by the reaction:

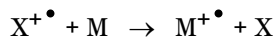

where X^+ is the ionized reagent gas and M is the analyte of interest. Examples of reagent gases used for charge exchange ionization include the noble gases (helium, neon, argon, krypton, xenon, and radon), nitrogen, carbon dioxide, carbon monoxide, hydrogen, and other gases that do not react “chemically” with the analyte. Each of these reagent gases, once ionized, has a recombination energy expressed as:

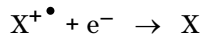

or simply the recombination of the ionized reagent with an electron to form a neutral species. If this energy is greater than the energy required to remove an electron from the analyte, then the first reaction above is exothermic and thermodynamically allowed.

Charge-exchange chemical ionization is not widely used for general analytical applications. It can, however, be used in some cases when other chemical ionization processes are not thermodynamically favored.

Negative CI Theory

Negative chemical ionization (NCI) is performed with analyzer voltage polarities reversed to select negative ions. There are several chemical mechanisms for NCI. Not all mechanisms provide the dramatic increases in sensitivity often associated with NCI. The four most common mechanisms (reactions) are:

- Electron capture
- Dissociative electron capture
- Ion pair formation
- Ion-molecule reactions

In all of the cases except the ion-molecule reactions, the reagent gas serves a function different from the function it serves in PCI. In NCI, the reagent gas is often referred to as the buffer gas. When the reagent gas is bombarded with high energy electrons from the filament, the following reaction occurs:

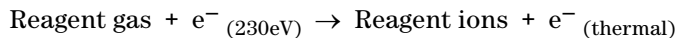

If the reagent gas is methane (Figure 36), the reaction is:

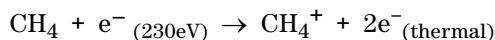

The thermal electrons have lower energy levels than the electrons from the filament. It is these thermal electrons that react with the sample molecules.

There are no negative reagent gas ions formed. This prevents the kind of background that is seen in PCI mode and is the reason for the much lower detection limits of NCI. The products of NCI can only be detected when the MSD is operating in negative ion mode. This operating mode reverses the polarity of all the analyzer voltages.

Carbon dioxide is often used as a buffer gas in NCI. It has obvious cost, availability, and safety advantages over other gases.

A Chemical Ionization Theory

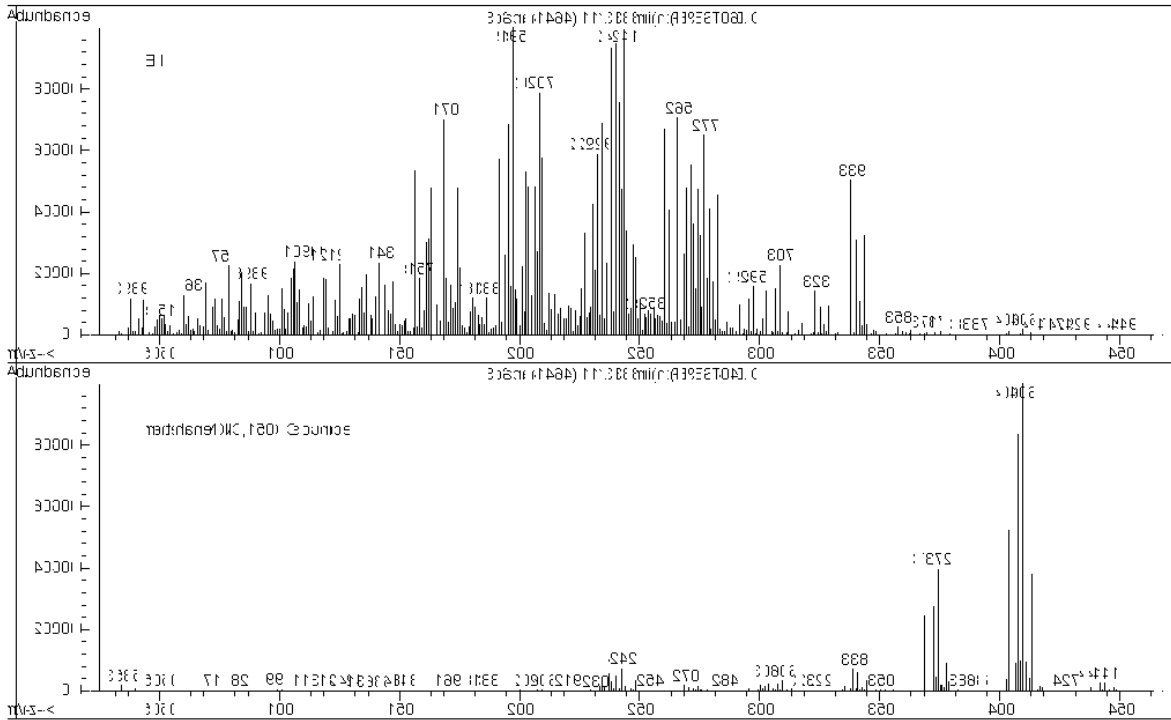

Figure 36 Endosulfan I (MW = 404): EI and methane NCI

Electron capture

Electron capture is the primary mechanism of interest in NCI. Electron capture (often referred to as high-pressure electron capture mass spectrometry or HPECMS) provides the high sensitivity for which NCI is known. For some samples under ideal conditions, electron capture can provide sensitivity as much as 10 to 1000 times higher than positive ionization.

Note that all the reactions associated with positive CI will also occur in NCI mode, usually with contaminants. The positive ions formed do not leave the ion source because of the reversed lens voltages, and their presence can quench the electron capture reaction.

The electron capture reaction is described by:



where MX is the sample molecule and the electron is a thermal (slow) electron generated by the interaction between high energy electrons and the reagent gas.

In some cases, the $\text{MX}^{-\bullet}$ radical anion is not stable. In those cases the reverse reaction can occur:

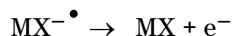

The reverse reaction is sometimes called autodetachment. This reverse reaction generally occurs very quickly. Thus, there is little time for the unstable anion to be stabilized through collisions or other reactions.

Electron capture is most favorable for molecules that have hetero-atoms. For example: nitrogen, oxygen, phosphorus, sulfur, silicon, and especially the halogens: fluorine, chlorine, bromine, and iodine.

The presence of oxygen, water, or almost any other contaminant interferes with the electron-attachment reaction. Contaminants cause the negative ion to be formed by the slower ion-molecule reaction. This generally results in less sensitivity. All potential contamination sources, especially oxygen (air) and water sources, must be minimized.

Dissociative electron capture

Dissociative electron capture is also known as dissociative resonance capture. It is a process similar to electron capture. The difference is that during the reaction, the sample molecule fragments or dissociates. The result is typically an anion and a neutral radical. Dissociative electron capture is illustrated by the reaction equation:

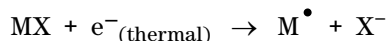

This reaction does not yield the same sensitivity as electron capture, and the mass spectra generated typically have lower abundance of the molecular ion.

As with electron capture, the products of dissociative electron capture are not always stable. The reverse reaction sometimes occurs. This reverse reaction is sometimes called an associative detachment reaction. The equation for the reverse reaction is:

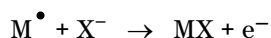

Ion pair formation

Ion pair formation is superficially similar to dissociative electron capture. The ion pair formation reaction is represented by the equation:

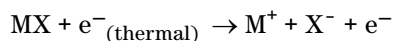

As with dissociative electron capture, the sample molecule fragments. Unlike dissociative electron capture however, the electron is not captured by the fragments. Instead, the sample molecule fragments in such a way that the electrons are distributed unevenly and positive and negative ions are generated.

Ion-molecule reactions

Ion-molecule reactions occur when oxygen, water, and other contaminants are present in the CI ion source. Ion-molecule reactions are two to four times slower than electron-attachment reactions and do not provide the high sensitivity associated with electron capture reactions. Ion-molecule reactions can be described by the general equation:

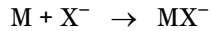

where X^- is most often a halogen or hydroxyl group that was created by ionization of contaminants by electrons from the filament. Ion-molecule reactions compete with electron capture reactions. The more ion-molecule reactions that occur, the fewer electron capture reactions occur.

A Chemical Ionization Theory



Agilent Technologies

© Agilent Technologies, Inc.

Printed in USA, June 2012



G3170-90036